

**Agilent InfiniiVision  
7000 Series  
Oscilloscopes**

**Service Guide**



**Agilent Technologies**

# Notices

© Agilent Technologies, Inc. 2008

No part of this manual may be reproduced in any form or by any means (including electronic storage and retrieval or translation into a foreign language) without prior agreement and written consent from Agilent Technologies, Inc. as governed by United States and international copyright laws.

## Manual Part Number

54695-97005, First Edition, February 2008

Printed in Malaysia

Agilent Technologies, Inc.  
395 Page Mill Road  
Palo Alto, CA 94303 USA

**A newer version of this manual  
may be available at**

[www.agilent.com/find/7000manual](http://www.agilent.com/find/7000manual)

Microsoft® is a U.S. registered trademark of Microsoft Corporation.

## Warranty

**The material contained in this document is provided “as is,” and is subject to being changed, without notice, in future editions. Further, to the maximum extent permitted by applicable law, Agilent disclaims all warranties, either express or implied, with regard to this manual and any information contained herein, including but not limited to the implied warranties of merchantability and fitness for a particular purpose. Agilent shall not be liable for errors or for incidental or consequential damages in connection with the furnishing, use, or performance of this document or of any information contained herein. Should Agilent and the user have a separate written agreement with warranty terms covering the material in this document that conflict with these terms, the warranty terms in the separate agreement shall control.**

## Technology Licenses

The hardware and/or software described in this document are furnished under a license and may be used or copied only in accordance with the terms of such license.

## Restricted Rights Legend

If software is for use in the performance of a U.S. Government prime contract or subcontract, Software is delivered and licensed as “Commercial computer software” as defined in DFAR 252.227-7014 (June 1995), or as a “commercial item” as defined in FAR 2.101(a) or as “Restricted computer software” as defined in FAR 52.227-19 (June 1987) or any equivalent agency regulation or contract clause. Use, duplication or disclosure of Software is subject to Agilent Technologies’ standard commercial license terms, and non-DOD Departments and Agencies of the U.S. Government will receive no greater than Restricted Rights as

defined in FAR 52.227-19(c)(1-2) (June 1987). U.S. Government users will receive no greater than Limited Rights as defined in FAR 52.227-14 (June 1987) or DFAR 252.227-7015 (b)(2) (November 1995), as applicable in any technical data.

## Safety Notices

### CAUTION

A **CAUTION** notice denotes a hazard. It calls attention to an operating procedure, practice, or the like that, if not correctly performed or adhered to, could result in damage to the product or loss of important data. Do not proceed beyond a **CAUTION** notice until the indicated conditions are fully understood and met.

### WARNING

A **WARNING** notice denotes a hazard. It calls attention to an operating procedure, practice, or the like that, if not correctly performed or adhered to, could result in personal injury or death. Do not proceed beyond a **WARNING** notice until the indicated conditions are fully understood and met.

# In This Service Guide

This book provides the service information for the Agilent 7000 Series Oscilloscopes. This manual is divided into these chapters:

## **1 Characteristics and Specifications**

This chapter contains a partial list of characteristics and specifications for the Agilent InfiniiVision 7000 Series Oscilloscopes.

## **2 Testing Performance**

This chapter explains how to verify correct oscilloscope operation and perform tests to ensure that the oscilloscope meets the performance specifications.

## **3 Calibrating and Adjusting**

This chapter explains how to adjust the oscilloscope for optimum operating performance.

## **4 Troubleshooting**

This chapter begins with suggestions for solving general problems that you may encounter with the oscilloscope. Procedures for troubleshooting the oscilloscope follow the problem solving suggestions.

## **5 Replacing Assemblies**

This chapter describes how to remove assemblies from the 7000A Series oscilloscope.

## **6 Replaceable Parts**

This chapter describes how to order replaceable assemblies and parts for the Agilent 7000 Series Oscilloscopes. It includes diagrams and parts lists for hardware that you can order.

At the front of the book you will find safety notice descriptions and document warranties.

### **Digital Channels**

Because all of the oscilloscopes in the Agilent 7000 Series have analog channels, the analog channel topics in this book apply to all instruments. Whenever a topic discusses the digital channels, that information applies only to Mixed-Signal Oscilloscope (MSO) models or DSO models that have been upgraded to an MSO.

### **Abbreviated instructions for pressing a series of keys**

Instructions for pressing a series of keys are written in an abbreviated manner. Instructions for pressing Key1, then pressing Key2, then pressing Key3 are abbreviated as follows:

Press **Key1** → **Key2** → **Key3**.

The keys may be front panel keys, or softkeys, which are located directly below the oscilloscope display.

# Contents

**Figures** 9

**Tables** 11

<b>1</b>	<b>Characteristics and Specifications</b>	<b>13</b>
	Power Requirements	14
	Measurement Category	15
	Measurement Category	15
	Measurement Category Definitions	15
	Transient Withstand Capability	16
	Environmental Conditions	17
	Specifications	18
	Contact us	19
<b>2</b>	<b>Testing Performance</b>	<b>21</b>
	List of Test Equipment	22
	Fluke MET/CAL Procedures	24
	Conventions	24
	To construct the test connector (for use with MSO models only)	25
	To test digital channels (MSO models only)	27
	To verify digital channel threshold accuracy (MSO models only)	28
	When to Test	28
	What to Test	28
	Verifying Test Results	28

To verify voltage measurement accuracy	32
To verify bandwidth	37
To verify horizontal Dt accuracy	42
To verify trigger sensitivity	44
Test Internal Trigger Sensitivity (all models)	46
Test External Trigger Sensitivity (2-channel models)	48
Test External Trigger Sensitivity (4-channel models)	51
Agilent 7000 Series Oscilloscopes Performance Test Record	54
<b>3 Calibrating and Adjusting</b>	<b>57</b>
User Calibration	59
To perform User Cal	59
User Cal Status	62
<b>4 Troubleshooting</b>	<b>63</b>
Solving General Problems with the Oscilloscope	64
Troubleshooting the Oscilloscope	67
Equipment required for troubleshooting	68
To check out the oscilloscope	68
To verify basic oscilloscope operation	70
To compensate the analog probes	71
Troubleshooting Flowchart	72
System board drawings	73
To check the 7000A Series oscilloscope power supply	75
To check the 7000A Series system board	76
To check the 7000A Series display	77
To check the fan	78
To run the internal self-tests	79
To verify default setup	79

<b>5</b>	<b>Replacing Assemblies</b>	<b>81</b>
	Removing the Handle	83
	To remove the Adjustable Legs	84
	To remove Cabinet	85
	To remove the Rear Deck Assembly	86
	To remove Acquisition and Inverter assemblies	88
	To remove the Front Panel assembly	91
	To remove the Fan assembly	97
	To remove the power supply shield	98
	To remove the power supply	100
	To remove the AC input board	101
<b>6</b>	<b>Replaceable Parts</b>	<b>103</b>
	Ordering Replaceable Parts	104
	Listed Parts	104
	Unlisted Parts	104
	Direct Mail Order System	104
	Exchange Assemblies	105
	Exploded Views	106
	Replaceable Parts List	108
	<b>Index</b>	<b>113</b>

## Contents



## Figures

- Figure 1. Constructing the 8-by-2 Connector 26
- Figure 2. Setting Up Equipment for Digital Channel Threshold Accuracy Test 30
- Figure 3. Setting up Equipment for Voltage Measurement Accuracy Test 35
- Figure 4. Using a Blocking Capacitor to Reduce Noise 36
- Figure 5. Setting Up Equipment for Bandwidth Verification Test 39
- Figure 6. Setting Up Equipment for Internal Trigger Sensitivity Test 46
- Figure 7. Setting Up Equipment for 2-Channel External Trigger Sensitivity Test 49
- Figure 8. Setting Up Equipment for 4-Channel External Trigger Sensitivity Test 52
- Figure 9. User Calibration cable for 2-channel oscilloscope 60
- Figure 10. User Calibration cable for 4-channel oscilloscope 61
- Figure 11. Example pulses 71
- Figure 12. System Board Test Points - Top Side 73
- Figure 13. System Board Test Points - Bottom Side 74
- Figure 14. Location of the Fan Connector 78
- Figure 15. Default setup screen 80
- Figure 16. Removing the handle 83
- Figure 17. Removing adjustable leg 84
- Figure 18. Removing cabinet 85
- Figure 19. Removing the rear deck assembly 86
- Figure 20. Separating front and rear deck assemblies 87
- Figure 21. Removing the T6 screws 88
- Figure 22. TORX T10 mounting screw locations 89
- Figure 23. Unlocking alignment pin 90

## Figures

Figure 24. Removal of inverter board	90
Figure 25. Removing cable shield	91
Figure 26. Removing keyboard cables	91
Figure 27. Removing knobs	92
Figure 28. Removing the bezel	92
Figure 29. Removal of softkey board	93
Figure 30. Removing front panel assembly from front deck	94
Figure 31. Front panel assembly separated from front deck	94
Figure 32. Separating front panel from printed circuit board	95
Figure 33. Front panel disassembly	95
Figure 34. Removing display assembly	96
Figure 35. Removing fan assembly	97
Figure 36. Power supply cover screw removal	98
Figure 37. Lifting power supply cover off	99
Figure 38. Removing the power supply	100
Figure 39. Removing the AC input board	101
Figure 40. Removing power switch extender	102
Figure 1. Exploded View 1 of 2	106
Figure 2. Exploded View 2 of 2	107

## Tables

Table 1. List of test equipment	22
Table 2. Conventions	24
Table 3. Materials required to construct the test connectors	25
Table 4. Equipment Required to Test Digital Channel Threshold Accuracy	29
Table 5. Threshold Accuracy Voltage Test Settings	31
Table 6. Equipment Required to Verify Voltage Measurement Accuracy	33
Table 7. Settings Used to Verify Voltage Measurement Accuracy	34
Table 8. Equipment Required to Verify Bandwidth	38
Table 9. Equipment Required to Verify Horizontal Dt Accuracy	42
Table 10. Equipment Required to Verify Trigger Sensitivity	45
Table 11. Equipment Required to Troubleshoot the Oscilloscope	68
Table 12. Regulator Voltage Test Points	76
Table 13. Display Signals on the System Board	77
Table 1. Replaceable Parts	108
Table 2. Power Cords	112



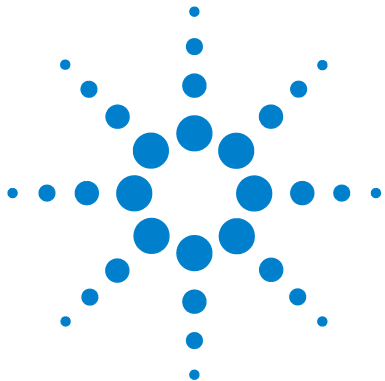

# 1 Characteristics and Specifications

This chapter contains a partial list of characteristics and specifications for the Agilent InfiniiVision 7000 Series Oscilloscopes.

For a full list of Agilent InfiniiVision 7000 Series Oscilloscopes characteristics and specifications see the data sheet.

The data sheet is available at [www.agilent.com/find/7000](http://www.agilent.com/find/7000).



## Power Requirements

**Line voltage and frequency range** ~Line 96-144 V/48-440 Hz,  
192-288 V/48-66 Hz, automatic selection

**Power usage** 120 W max

## Measurement Category

### Measurement Category

The InfiniiVision 7000 Series oscilloscope is intended to be used for measurements in Measurement Category I.

**WARNING**

**Use this instrument only for measurements within its specified measurement category.**

---

### Measurement Category Definitions

Measurement category I is for measurements performed on circuits not directly connected to MAINS. Examples are measurements on circuits not derived from MAINS, and specially protected (internal) MAINS derived circuits. In the latter case, transient stresses are variable; for that reason, the transient withstand capability of the equipment is made known to the user.

Measurement category II is for measurements performed on circuits directly connected to the low voltage installation. Examples are measurements on household appliances, portable tools and similar equipment.

Measurement category III is for measurements performed in the building installation. Examples are measurements on distribution boards, circuit-breakers, wiring, including cables, bus-bars, junction boxes, switches, socket-outlets in the fixed installation, and equipment for industrial use and some other equipment, for example, stationary motors with permanent connection to the fixed installation.

Measurement category IV is for measurements performed at the source of the low-voltage installation. Examples are electricity meters and measurements on primary overcurrent protection devices and ripple control units.

## Transient Withstand Capability

### CAUTION

Maximum input voltage for analog inputs  
CAT I 300 Vrms, 400 Vpk; transient overvoltage 1.6 kVpk  
CAT II 100 Vrms, 400 Vpk  
with 10073C or 10074C 10:1 probe: CAT I 500 Vpk, CAT II 400 Vpk

---

### CAUTION

Do not exceed 5 Vrms in 50  $\Omega$  mode. Input protection is enabled in 50  $\Omega$  mode, and the 50  $\Omega$  load will disconnect if greater than 5 Vrms is detected. However, the input could still be damaged, depending on the time constant of the signal. The 50  $\Omega$  input protection mode only functions when the oscilloscope is powered on.

---

### CAUTION

Maximum input voltage for logic channels:  
 $\pm 40$  V peak CAT I; transient overvoltage 800 Vpk

---



## Environmental Conditions

**Environment** Indoor use only.

**Ambient temperature** Operating  $-10\text{ }^{\circ}\text{C}$  to  $+55\text{ }^{\circ}\text{C}$ ;  
non-operating  $-65\text{ }^{\circ}\text{C}$  to  $+71\text{ }^{\circ}\text{C}$

**Humidity** Operating 95% RH at  $40\text{ }^{\circ}\text{C}$  for 24 hr; non-operating  
90% RH at  $65\text{ }^{\circ}\text{C}$  for 24 hr

**Altitude** Operating to 4,570 m (15,000 ft); non-operating to  
15,244 m (50,000 ft)

**Overvoltage Category** This product is intended to be powered  
by MAINS that comply to Overvoltage Category II, which is  
typical of cord-and-plug connected equipment.

**Pollution Degree** The InfiniiVision 7000 Series Oscilloscope  
may be operated in environments of Pollution Degree 2 (or  
Pollution Degree 1).

**Pollution Degree Definitions** Pollution Degree 1: No pollution or  
only dry, non-conductive pollution occurs. The pollution has no  
influence. Example: A clean room or climate controlled office  
environment.

Pollution Degree 2. Normally only dry non-conductive pollution  
occurs. Occasionally a temporary conductivity caused by  
condensation may occur. Example: General indoor  
environment.

Pollution Degree 3: Conductive pollution occurs, or dry,  
non-conductive pollution occurs which becomes conductive due  
to condensation which is expected. Example: Sheltered outdoor  
environment.

## Specifications

Please see the InfiniiVision 7000 Series Oscilloscopes Data Sheet for complete, up-to-date specifications and characteristics.

To download a copy of the data sheet please visit:  
[www.agilent.com/find/7000](http://www.agilent.com/find/7000).

Or go to the Agilent home page at [www.agilent.com](http://www.agilent.com) and search for **7000 series oscilloscopes data sheet**.

To order a data sheet by phone, please contact your local Agilent office. A contact list is provided on the next page. The most up-to-date list is available at:  
[www.agilent.com/find/contactus](http://www.agilent.com/find/contactus)

## Contact us

### Americas

Canada (877) 894-4414  
Latin America 305 269 7500  
United States (800) 829-4444

### Asia Pacific

Australia 1 800 629 485  
China 800 810 0189  
Hong Kong 800 938 693  
India 1 800 112 929  
Japan 81 426 56 7832  
Korea 080 769 0800  
Malaysia 1 800 888 848  
Singapore 1 800 375 8100  
Taiwan 0800 047 866  
Thailand 1 800 226 008

### Europe

Austria 0820 87 44 11  
Belgium 32 (0) 2 404 93 40  
Denmark 45 70 13 15 15  
Finland 358 (0) 10 855 2100  
France 0825 010 700  
Germany 01805 24 6333\*  
\*0.14€/minute  
Ireland 1890 924 204  
Italy 39 02 92 60 8484  
Netherlands 31 (0) 20 547 2111  
Spain 34 (91) 631 3300  
Sweden 0200-88 22 55  
Switzerland (French)  
44 (21) 8113811 (Opt 2)  
Switzerland (German)  
0800 80 53 53 (Opt 1)  
United Kingdom 44 (0) 7004 666666  
Other European countries:  
[www.agilent.com/find/contactus](http://www.agilent.com/find/contactus)

## **1 Characteristics and Specifications**

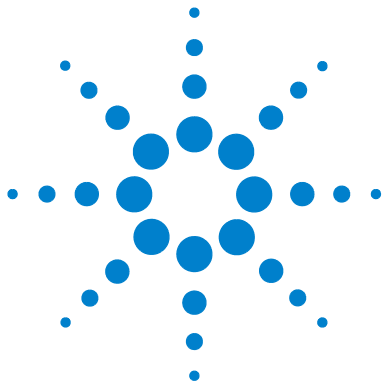

## 2 Testing Performance

This chapter explains how to verify correct oscilloscope operation and perform tests to ensure that the oscilloscope meets the performance specifications.

To completely test and troubleshoot MSO models, create and use the test connector accessory as described in this chapter.

- The test connector is only required for oscilloscopes that have the MSO option licensed (enabled).
- The connector is used in the digital channel threshold accuracy test.
- The test connector keeps electrical distortion to a minimum and makes it easy for you to connect the oscilloscope probes to function generators and measurement equipment.

### Let the Equipment Warm Up Before Testing

For accurate test results, let the test equipment and the oscilloscope warm up 30 minutes before testing.

### Verifying Test Results

During the tests, record the readings in the Performance Test Record on [page 54](#). To verify whether a test passes, verify that the reading is within the limits in the Performance Test Record.

**If a performance test fails**

If a performance test fails, first perform the User Cal procedure. Press the following keys to access User Cal: Utility→Service→Start User Cal.



## List of Test Equipment

Below is a list of test equipment and accessories required to perform the performance test verification procedures.

**Table 1** List of test equipment

Equipment	Critical Specifications	Recommended Model/ Part Number
Test connector, 8-by-2*	See <a href="#">page 25</a> for instructions on building test connector.	n/a
Digital Multimeter	0.1 mV resolution, 0.005% accuracy	Agilent 34401A
Power Splitter	Outputs differ by 0.15 dB	Agilent 11667B
Oscilloscope Calibrator	DC offset voltage of -5.5 V to 35.5 V, 0.1 V resolution 25 MHz—500 MHz sine wave, 5 ppm	Fluke 5820A
Signal Generator	25 MHz, 100 MHz, 350 MHz, 500 MHz, and 1 GHz sine waves	Agilent N5181A, or E4400B, or 8648A
Power Meter & Sensor	1 GHz $\pm$ 3% accuracy	Agilent E4418B & 8482A
BNC banana cable	BNC (m) to dual banana	Pomona 2BC-BNC-36 or Agilent 11001-66001
BNC cable (qty 3)	BNC - BNC, 48" length	Agilent 10503A <sup>†</sup>
Cable	Type N (m) 609.6 mm (24 in.)	Agilent 11500B
Probe cable*	No substitute	Agilent 01650-61607 <sup>†</sup> or Agilent 54620-68701
Adapter	BNC(f) to banana(m)	Agilent 1251-2277 <sup>†</sup>
Adapter	BNC Tee (m) (f) (f)	Agilent 1250-0781 <sup>†</sup> or Pomona 3285
Adapter	Type N (m) to BNC (m)	Agilent 1250-0082 or Pomona 3288 with Pomona 3533
Blocking capacitor and shorting cap	Note: if a BNC blocking capacitor is not available use an SMA blocking capacitor.	Agilent 10240-70001 + Agilent 1250-0774 or Agilent 11742A + Pomona 4288 + Pomona 5088A
Adapter (qty 3)	N(m) to BNC(f)	Agilent 1250-0780

**Table 1** List of test equipment

<b>Equipment</b>	<b>Critical Specifications</b>	<b>Recommended Model/ Part Number</b>
Feedthrough	50Ω BNC (f) to BNC (m)	Agilent 0960-0301

\* Required only for testing digital channels of oscilloscopes that have the MSO option.

Most parts and equipment are available at [www.agilent.com](http://www.agilent.com). See respective manufacturer's websites for their equipment.

† These parts available at [www.parts.agilent.com](http://www.parts.agilent.com) at the time this manual was published.

## Fluke MET/CAL Procedures

Fluke MET/CAL procedures are available for the 7000 Series oscilloscopes.



The MET/CAL badge with "PROCEDURES AVAILABLE" signifies that Fluke has created Warranted MET/CAL procedures to verify the performance of this instrument using MET/CAL metrology software. These procedures can be obtained from Fluke. Please see <http://www.fluke.com> and search for MET/CAL for more information.

## Conventions

The following conventions will be used when referring to oscilloscope models throughout this chapter.

**Table 2** Conventions

<b>Models</b>	<b>Referred to as:</b>
MSO/DS07032A, MSO/DS07034A	350 MHz Models
MSO/DS07052A, MSO/DS07054A	500 MHz Models
MSO/DS07104A	1 GHz Models



## To construct the test connector (for use with MSO models only)

Agilent 7000 Series Oscilloscopes that have digital channels enabled require the test connector described below. Follow the steps to build the test connector.

**Table 3** Materials required to construct the test connectors

Description	Recommended Part	Qty
BNC (f) Connector	Agilent 1250-1032 or Pomona 4578	1
Berg Strip, 8-by-2	3M .100" x .100" Pin Strip Header or similar	1 strip, cut to length (8x2)
Jumper wire		

- 1** Obtain a BNC connector and an 8-by-2 section of Berg strip. A longer strip can be cut to length using wire cutters.
- 2** On one side of the Berg strip, solder a jumper wire to all of the pins (shown in [Figure 1](#) on page 26).
- 3** On the other side of the Berg strip, solder another jumper wire to all of the pins.
- 4** Solder the center of the BNC connector to a center pin on one of the rows on the Berg strip.
- 5** Solder the ground tab of the BNC connector to a center pin on the other row on the Berg strip.

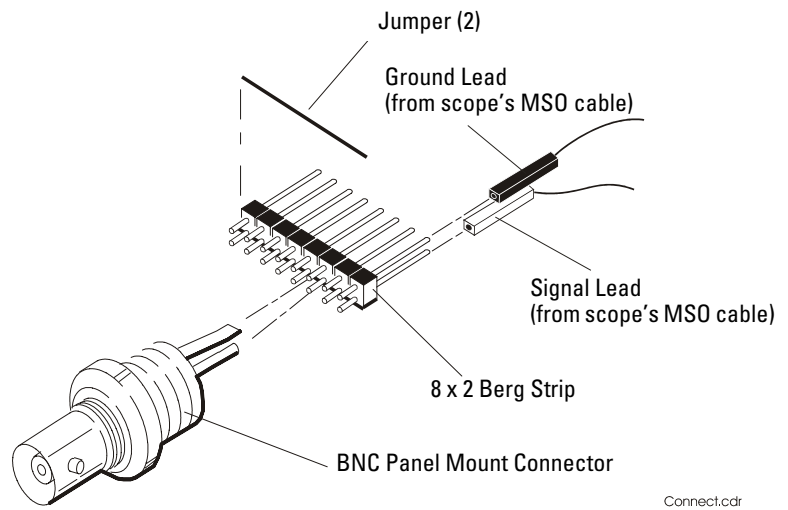

**Figure 1** Constructing the 8-by-2 Connector

## To test digital channels (MSO models only)

The acquisition system testing provides confidence that the acquisition system is functioning correctly. It does not, however, check a particular specification.

- 1 Disconnect all probes from the circuit under test and from any other input source.
- 2 Using probe leads and grabbers, connect digital channels D0, D1, D2, and D3 to the Probe Comp signal on the center of the front panel.
- 3 Press the **AutoScale** key.

If four square waves appear, the acquisition system is functioning correctly.

If the square waves do not appear, go to the “Troubleshooting” chapter. Then return here to finish testing the digital channels.

- 4 Disconnect the digital channels from the calibration point.
- 5 Use steps 2 and 3 to test the following sets of digital channels. After you test one set of digital channels, remove them before connecting the next set.
  - D4, D5, D6, D7
  - D8, D9, D10, D11
  - D12, D13, D14, D15

## To verify digital channel threshold accuracy (MSO models only)

This test verifies the digital channel threshold accuracy specification of the Agilent 7000 Series Oscilloscopes.

Threshold accuracy test limits =  $\pm(100 \text{ mV} + 3\% \text{ of threshold setting})$

### When to Test

You should perform this test every 12 months or after 2000 hours of operation, whichever comes first.

### What to Test

Use these instructions to test the threshold settings of digital channels D7-D0. Then, use the same instructions to test digital channels D15-D8.

### Verifying Test Results

After each threshold test, record the voltage reading in the Performance Test Record on [page 54](#). To verify whether a test passes, verify that the voltage reading is within the limits in the Performance Test Record.

**Table 4** Equipment Required to Test Digital Channel Threshold Accuracy

Equipment	Critical Specifications	Recommended Model/Part
Digital Multimeter	0.1 mV resolution, 0.005% accuracy	Agilent 34401A
Oscilloscope Calibrator	DC offset voltage 6.3 V	Fluke 5820A
BNC-Banana Cable		Agilent 11001-66001 or Pomona 2BC-BNC-36
BNC Tee		Agilent 1250-0781 or Pomona 3285
50 $\Omega$ BNC Cable		Agilent 10503A
BNC Test Connector, 8-by-2		User-built (See <a href="#">page 25</a> )
Probe Cable		Agilent 01650-61607 or Agilent 54620-68701

- 1** Turn on the test equipment and the oscilloscope. Let them warm up for 30 minutes before starting the test.
- 2** Set up the oscilloscope calibrator.
  - a** Set the oscilloscope calibrator to provide a DC offset voltage at the Channel 1 output.
  - b** Use the multimeter to monitor the oscilloscope calibrator DC output voltage.
- 3** Use the 8-by-2 test connector and the BNC cable assembly to connect digital channels D0-D7 to one side of the BNC Tee. Then connect the D0-D7 ground lead to the ground side of the 8-by-2 connector. See [Figure 2](#).

## 2 Testing Performance

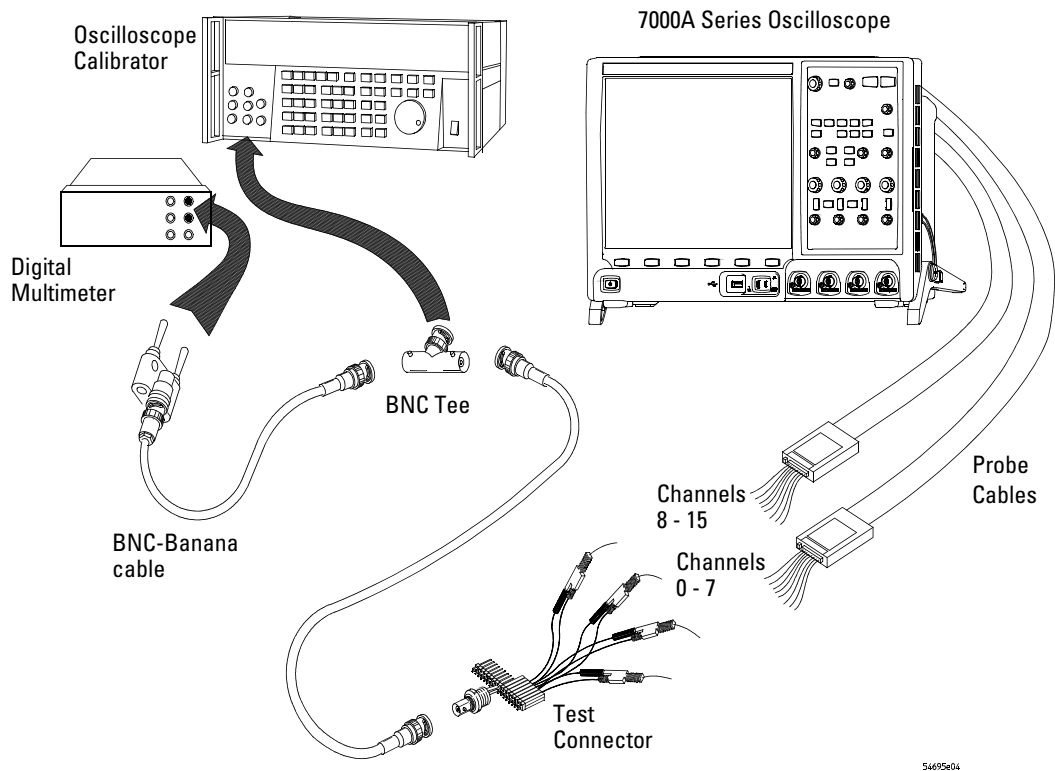

**Figure 2** Setting Up Equipment for Digital Channel Threshold Accuracy Test

- 4 Use a BNC-banana cable to connect the multimeter to the other side of the BNC Tee.
- 5 Connect the BNC Tee to the Channel 1 output of the calibrator as shown in [Figure 2](#).
- 6 On the oscilloscope, press the **D15-D0** key, then press the **Thresholds** softkey, then press the **D7 - D0** softkey repeatedly until the check mark is next to **User**.
- 7 Press the **User** softkey to the right of the **D7 - D0** softkey, then turn the Entry knob (↻) on the front panel of the

oscilloscope to set the threshold test settings as shown in [Table 5](#).

**Table 5** Threshold Accuracy Voltage Test Settings

Threshold voltage setting (in oscilloscope User softkey)	DC offset voltage setting (on oscilloscope calibrator)	Limits
+5.00 V	+5.250 V $\pm$ 1 mV dc	Lower limit = +4.750 V Upper limit = +5.250 V
-5.00 V	-4.750 V $\pm$ 1 mV dc	Lower limit = -5.250 V Upper limit = -4.750 V
0.00 V	+100m V $\pm$ 1 mV dc	Upper limit = +100 mV Lower limit = -100 mV

**8** Do the following steps for each of the threshold voltage levels shown in [Table 5](#).

- a** Set the threshold voltage shown in the **User** softkey using the Entry knob on the oscilloscope.
- b** Enter the corresponding DC offset voltage on the oscilloscope calibrator front panel. Then use the multimeter to verify the voltage.

Digital channel activity indicators are displayed on the status line at the top of the oscilloscope display. The activity indicators for D7-D0 should show all of the channels at digital high levels.

- c** Use the knob on the oscilloscope calibrator to decrease the offset voltage, in increments of 10 mV, until the activity indicators for digital channels D7-D0 are all at digital low levels. Record the oscilloscope calibrator voltage in the Performance Test Record (see [page 54](#)).
- d** Use the knob on the oscilloscope calibrator to increase the offset voltage, in increments of 10 mV, until the activity indicators for digital channels D7-D0 are all at digital high levels. Record the oscilloscope calibrator voltage in the Performance Test Record (see [page 54](#)).

Before proceeding to the next step, make sure that you have recorded the oscilloscope calibrator voltage levels for each of the threshold settings shown in [Table 5](#).

- 9** Use the 8-by-2 test connector to connect digital channels D15-D8 to the output of the oscilloscope calibrator. Then connect the D15-D8 ground lead to the ground side of the 8-by-2 connector.
- 10** Repeat this procedure (steps 6 through 8) for digital channels D15-D8 to verify threshold accuracy and record the threshold levels in the Performance Test Record (see [page 54](#)). Be sure to set the thresholds with the **User** softkey for the appropriate set of channels.

### To verify voltage measurement accuracy

This test verifies the accuracy of the analog channel voltage measurement for each channel. In this test, you will measure the dc voltage output of an oscilloscope calibrator using dual cursors on the oscilloscope, and compare the results with the multimeter reading.

Test limits:  $\pm 2.0\%$  of full scale  $\pm 1$  LSB\*

- Full scale is defined as 32 mV on the 2 mV/div range.
- Full scale on all other ranges is defined as 8 divisions times the V/div setting.

\*1 LSB = 0.4% of full scale



**Table 6** Equipment Required to Verify Voltage Measurement Accuracy

Equipment	Critical Specifications	Recommended Model/Part
Oscilloscope Calibrator	14 mV to 35 Vdc, 0.1 V resolution	Fluke 5820A
Digital multimeter	Better than 0.01% accuracy	Agilent 34401A
Cable	BNC, Qty 2	Agilent 10503A
Shorting cap	BNC	Agilent 1250-0774
Adapter	BNC (f) to banana (m)	Agilent 1251-2277
Adapter	BNC tee (m) (f) (f)	Agilent 1250-0781 or Pomona 3285
Blocking capacitor		Agilent 10240-70001 + Agilent 1250-0774 or Agilent 11742A + Pomona 4288 + Pomona 5088A

- 1 Set up the oscilloscope.
  - a Adjust the channel 1 position knob to place the baseline at 0.5 major division from the bottom of the display.
  - b Set the Volts/Div setting to the value in the first line in [Table 7](#).

**Table 7** Settings Used to Verify Voltage Measurement Accuracy

Volts/Div Setting	Oscilloscope Calibrator Setting	Test Limits		
5 V/Div	35 V	34.04 V	to	35.96 V
2 V/Div	14 V	13.616 V	to	14.384 V
1 V/Div	7 V	6.808 V	to	7.192 V
500 mV/Div	3.5 V	3.404 V	to	3.596 V
200 mV/Div	1.4 V	1.3616 V	to	1.4384 V
100 mV/Div	700 mV	680.8 mV	to	719.2 mV
50 mV/Div	350 mV	340.4 mV	to	359.6 mV
20 mV/Div	140 mV	136.16 mV	to	143.84 mV
10 mV/Div	70 mV	68.08 mV	to	71.92 mV
5 mV/Div	35 mV	34.04 mV	to	35.96 mV
2 mV/Div <sup>1</sup>	14 mV	13.232 mV	to	14.768 mV

<sup>1</sup> Full scale is defined as 32 mV on the 2 mV/div range.

Full scale on all other ranges is defined as 8 divisions times the V/div setting.

- c** Press the **Acquire** key. Then press the **Averaging** softkey and set **#Avs** to 64.

Wait a few seconds for the measurement to settle.

- 2** Press the **Cursors** key, set the **Mode** softkey to **Normal**, then press the **XY** softkey and select **Y**. Press the **Y1** softkey, then use the Entry knob (labeled  on the front panel) to set the Y1 cursor on the baseline of the signal.
- 3** Use the BNC tee and cables to connect the oscilloscope calibrator /power supply to both the oscilloscope and the multimeter (see [Figure 3](#)).

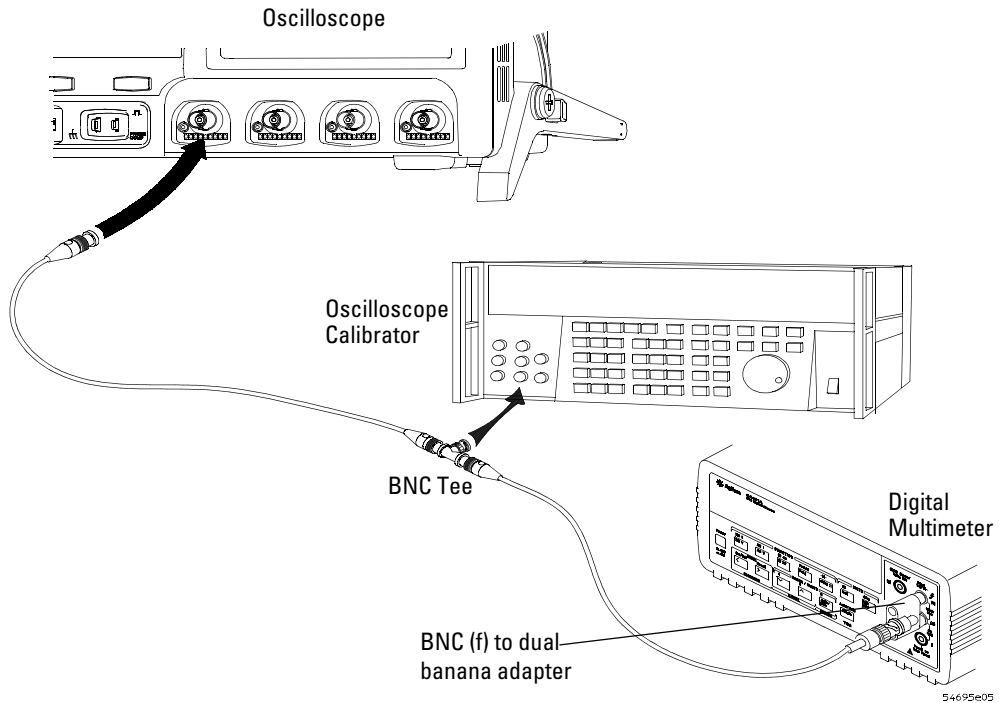

**Figure 3** Setting up Equipment for Voltage Measurement Accuracy Test

- 4 Adjust the output so that the multimeter reading displays the first Volts/div calibrator setting value in [Table 7](#).

Wait a few seconds for the measurement to settle.

- 5 Press the **Y2** softkey, then position the Y2 cursor to the center of the voltage trace using the Entry knob.

The  $\Delta Y$  value on the lower line of the display should be within the test limits of [Table 7](#). If a result is not within the test limits, go to the “Troubleshooting” chapter. Then return here.

- 6 Continue to check the voltage measurement accuracy with the remaining Volts/div setting values in [Table 7](#).

## 2 Testing Performance

- 7 When you are finished checking all of the voltage values, disconnect the oscilloscope calibrator from the oscilloscope.
- 8 Repeat this procedure for the remaining channels to be tested.

### Use a Blocking Capacitor to Reduce Noise

On the more sensitive ranges, such as 2 mV/div and 5 mV/div, noise may be a factor. To eliminate the noise, add a BNC Tee, blocking capacitor, and shorting cap at the oscilloscope channel input to shunt the noise to ground. See [Figure 4](#). If a BNC capacitor is not available, use an SMA blocking capacitor, adapter, and cap. See “[Blocking capacitor and shorting cap](#)” in the equipment list on [page 22](#) for details.

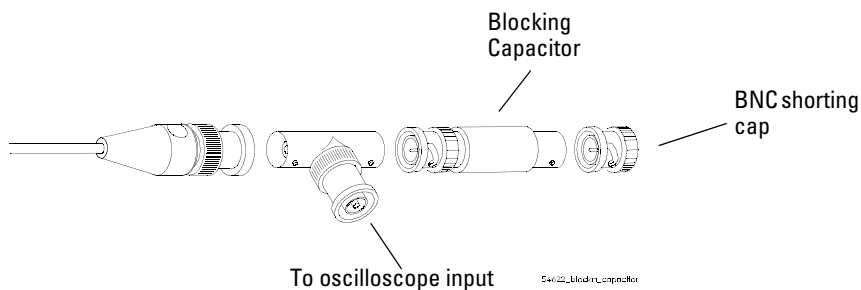

**Figure 4** Using a Blocking Capacitor to Reduce Noise

## To verify bandwidth

This test checks the bandwidth of the oscilloscope. In this test you will use a signal generator and a power meter.

### 1 GHz Models

Test limits at 2 mV/div to 5 V/div

- All channels ( $\pm 3$  dB)
  - dc to 1 GHz

### 500 MHz Models

Test limits at 2 mV/div to 5 V/div

- All channels ( $\pm 3$  dB)
  - dc to 500 MHz

### 350 MHz Models

Test limits at 2 mV/div to 5 V/div

- All channels ( $\pm 3$  dB)
  - dc to 350 MHz

**Table 8** Equipment Required to Verify Bandwidth

Equipment	Critical Specifications	Recommended Model/Part
Signal Generator	100 kHz - 1 GHz at 200 mVrms	Agilent N5181A, E4400B, or 8648A
Power Meter/Sensor	1 MHz - 1 GHz $\pm 3\%$ accuracy	Agilent E4418B/8482A
Power Splitter	outputs differ by $< 0.15$ dB	Agilent 11667A
Cable	Type N (m) 24 inch	Agilent 11500B
Adapter	Type N (m) to BNC (m)	Agilent 1250-0082 or Pomona 3288 with Pomona 3533

- 1** Connect the equipment (see [Figure 5](#)).
  - a** Use the N cable to connect the signal generator to the input of the power splitter input.
  - b** Connect the power sensor to one output of the power splitter.
  - c** Use an N-to-BNC adapter to connect the other splitter output to the channel 1 input.

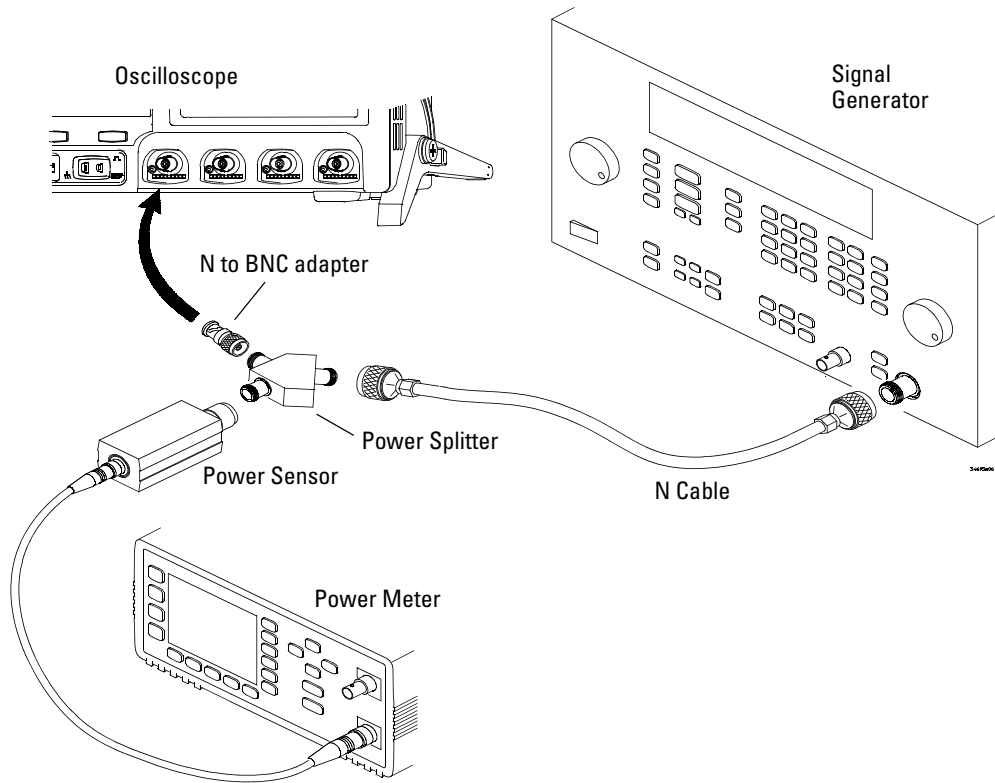

**Figure 5** Setting Up Equipment for Bandwidth Verification Test

**2** Set up the power meter.

Set the power meter to display measurements in units of watts.

- 3 Set up the oscilloscope.
  - a Press the **Save/Recall** key, then press the **Default Setup** softkey.
  - b Press the **Acquire** key, then press the **Realtime** softkey to unselect Realtime.
  - c Set channel 1 **Coupling** to **DC**.
  - d Set channel 1 **Imped** to **50 Ohm**.
  - e Set the time base to 500 ns/div.
  - f Set the Volts/Div for channel 1 to 200 mV/div.
  - g Press the **Acquire** key, then press the **Averaging** softkey.
  - h Turn the Entry knob to set **# Avgs** to 8 averages.
- 4 Set the signal generator for 1 MHz and six divisions of amplitude.

The signal on the oscilloscope screen should be about five cycles at six divisions amplitude.

- 5 Set up the Amplitude measurement
  - a Press the **Quick Meas** key.
  - b Press the **Clear Meas** softkey.
  - c Press the **Select:** softkey and use the Entry knob to select **Std Deviation** within the select menu.
  - d Press the **Measure Std Dev** softkey.
- 6 Note the oscilloscope Std Dev(1) reading at the bottom of the screen. (This is the RMS value with any dc offset removed.)
- 7 Set the power meter Cal Factor % to the 1 MHz value on the calibration chart on the power sensor.
- 8 Note the reading on the power meter and covert to Vrms using the expression:

$$V_{in_{1MHz}} = \sqrt{P_{meas_{1MHz}} \times 50\Omega}$$

For example, if the power meter reading is 892 uW, then  $V_{in_{1MHz}} = (892 * 10^{-6} * 50\Omega)^{1/2} = 211.2 \text{ mV}_{\text{rms}}$ .

- 9 Change the signal generator output frequency according to the maximum frequency for the oscilloscope using the following:



- 1 GHz Models: 1 GHz
  - 500 MHz Models: 500 MHz
  - 350 MHz Models: 350 MHz
- 10** Referencing the frequency from step 9, set the power meter Cal Factor % to the frequency value on the calibration chart on the power sensor.
- 11** Set the oscilloscope sweep speed according to the following:
- 1 GHz Models: 500 ps/div
  - 500 MHz Models: 1 ns/div
  - 350 MHz Models: 2 ns/div
- 12** Note the oscilloscope Std Dev(1) reading at the bottom of the screen.
- 13** Note the reading on the power meter and convert to  $V_{rms}$  using the expression:

$$V_{in_{max\_freq}} = \sqrt{P_{meas_{max\_freq}} \times 50\Omega}$$

- 14** Calculate the response using the expression:

$$\text{response(dB)} = 20 \log_{10} \left[ \frac{V_{out_{max\_freq}} / V_{in_{max\_freq}}}{V_{out_{1MHz}} / V_{in_{1MHz}}} \right]$$

**Example**

If:

$$P_{meas_{1\_MHz}} = 892 \text{ uW}$$

$$\text{Std Dev}(n)_{1MHz} = 210.4 \text{ mV}$$

$$P_{meas_{max\_freq}} = 687 \text{ uW}$$

$$\text{Std Dev}(n)_{max\_freq} = 161.6 \text{ mV}$$

Then after converting the values from the power meter to  $V_{rms}$ :

$$\text{response(dB)} = 20 \log_{10} \left[ \frac{161.6 \text{ mV} / 185.3 \text{ mV}}{210.4 \text{ mV} / 211.2 \text{ mV}} \right] = -1.16 \text{ dB}$$

- 15** The result from step 14 should be between +3.0 dB and -3.0 dB. Record the result in the Performance Test Record (see [page 54](#)).

- 16 Move the power splitter from the channel 1 to the channel 2 input.
- 17 Turn off the current channel and turn on the next channel using the channel keys.
- 18 Repeat steps 3 through 17 for the remaining channels, setting the parameters of the channel being tested where appropriate.

## To verify horizontal $\Delta t$ accuracy

This test verifies the horizontal  $\Delta t$  accuracy. In this test, you will use the oscilloscope to measure the output of a time mark generator.

Test limits:  $\pm 0.0015\%$  of reading  $\pm 0.1\%$  of full scale  $\pm 20$  ps (same channel)

**Table 9** Equipment Required to Verify Horizontal  $\Delta t$  Accuracy

Equipment	Critical Specifications	Recommended Model/Part
Oscilloscope Calibrator	Stability 5 ppm after 1/2 hour	Fluke 5820A
Cable	BNC, 3 feet	Agilent 10503A

- 1 Connect the equipment:
  - a Connect the calibrator output to the oscilloscope channel 1 input.
- 2 Set up the signal source.
  - 1 Select **Marker** on the oscilloscope calibrator.
  - 2 Set the calibrator for 100  $\mu$ s markers (period = 100  $\mu$ s).

- 3 Set up the oscilloscope.
  - a Set channel 1 **Coupling** to **DC**.
  - b Set channel 1 **Imped** to **50 Ohm**.
  - c Press the **Display** key, then set the **Vectors** softkey to off.
  - d Press the **AutoScale** key.
  - e Set the time base to 20  $\mu\text{s}/\text{div}$ .
  - f Press the **Menu/Zoom** key, then set the **Time Ref** softkey to **Left**.
  - g Adjust the Trigger Level knob to obtain a stable display.

- 4 Press the **Quick Meas** softkey, set the **Source** softkey to **1**, then press **Select** and choose **Period**. Press the **Measure** softkey and measure the following:

Period 100  $\mu\text{s}$  – The test limits are 99.8  $\mu\text{s}$  to 100.2  $\mu\text{s}$ .

If the measurements are not within the test limits, go to the “Troubleshooting” chapter. Then return here.

- 5 Change the calibrator to 100 ns markers. Change the time base to 20 ns/div. Adjust the trigger level to obtain a stable display.

- 6 Measure the following. If the measurements are not within the test limits, go to the “Troubleshooting” chapter. Then return here.

Period 100 ns— The test limits are 99.8 ns to 100.2 ns.

- 7 Change the time base to 2 ns/div and the calibrator to 5 ns markers.

- 8 Measure the following. If the measurement is not within the test limits, go to the “Troubleshooting” chapter. Then return here.

Period 5 ns – The test limits are 4.96 ns to 5.04 ns.

### To verify trigger sensitivity

This test verifies the trigger sensitivity. In this test, you will apply a sine wave to the oscilloscope at the upper bandwidth limit. You will then decrease the amplitude of the signal to the specified levels, and check to see if the oscilloscope is still triggered.

Test limits for:

- Internal trigger on all models:
  - < 10 mV/div: greater of 1 div or 5 mV<sub>pp</sub>
  - ≥10 mV/div: 0.6 div
- External trigger on all 2-channel models (MSO/DSO7xx2A):
  - Trigger range: 1.0V
  - DC to 100 MHz: < 100 mV<sub>pp</sub>
  - >100 MHz to max bandwidth: < 200 mV<sub>pp</sub>
  - Trigger range: 8.0V
  - DC to 100 MHz: < 250 mV<sub>pp</sub>
  - >100 MHz to max bandwidth: < 500 mV<sub>pp</sub>
- External trigger on 4-channel models:
  - (MSO/DSO7104A/7054A/7034A)
  - DC to 500 MHz: < 500 mV<sub>pp</sub>

**Table 10** Equipment Required to Verify Trigger Sensitivity

Equipment	Critical Specifications	Recommended Model/Part
Signal Generator	25-MHz, 100-MHz, 350-MHz, 500-MHz, and 1 GHz sine waves	Agilent N5181A, E4400B, or 8648A
Power splitter	Outputs differ < 0.15 dB	Agilent 11667A
Cable	BNC, Qty 3	Agilent 10503A
Adapter	N (m) to BNC (f), Qty 3	Agilent 1250-0780
Feedthrough	50Ω BNC (f) to BNC (m)	Agilent 0960-0301

## Test Internal Trigger Sensitivity (all models)

- 1 Connect the equipment (see Figure 6).
  - a Connect the signal generator output to the oscilloscope channel 1 input.

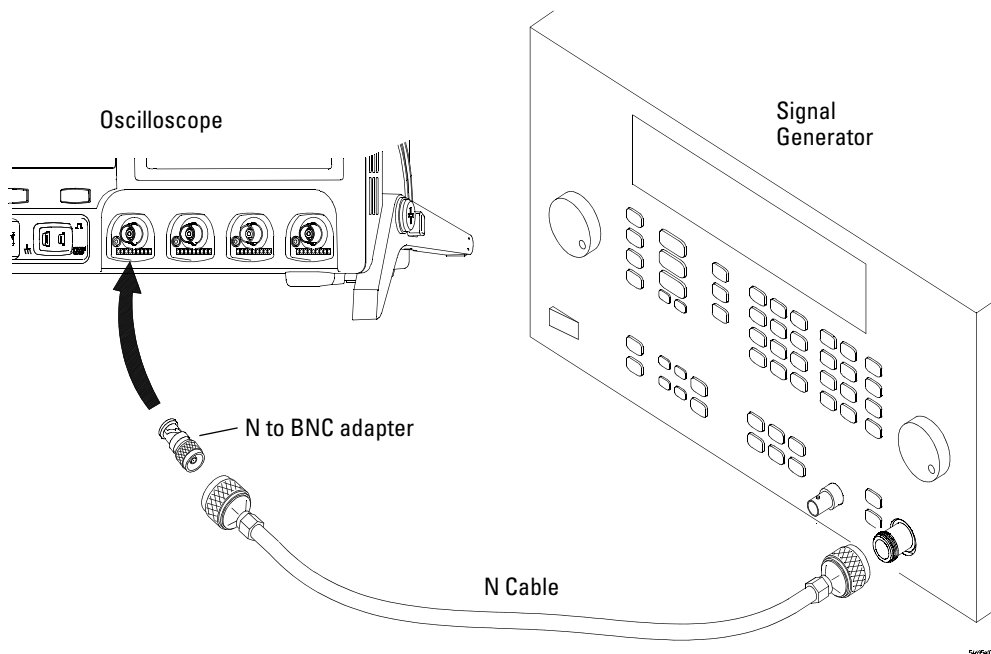

**Figure 6** Setting Up Equipment for Internal Trigger Sensitivity Test

**2** Verify the trigger sensitivity at maximum bandwidth.

1 GHz models: 1 GHz

500 MHz models: 500 MHz

350 MHz models: 350 MHz

**a** Press the **Save/Recall** key, then press the **Default Setup** softkey.

**b** Set channel 1 **Imped** to **50 Ohm**.

**c** Set the output frequency of the signal generator to the maximum bandwidth of the oscilloscope and set the amplitude to about 10 mV<sub>pp</sub>.

**d** Press the **AutoScale** key.

**e** Set the time base to 10 ns/div.

**f** Set channel 1 to 5 mV/div.

**g** Decrease the amplitude from the signal generator until 1 vertical division of the signal is displayed.

The trigger is stable when the displayed waveform is stable. If the trigger is not stable, try adjusting the trigger level. If adjusting the trigger level makes the trigger stable, the test still passes. If adjusting the trigger does not help, see the "Troubleshooting" chapter. Then return here.

**h** Record the result as Pass or Fail in the Performance Test Record (see [page 54](#)).

**3** Repeat this procedure for the remaining oscilloscope channels.

## Test External Trigger Sensitivity (2-channel models)

Verify the external trigger sensitivity at these settings:

Trigger range = +/- 1 V

- 500 MHz (MSO/DSO7052A), 200 mV<sub>pp</sub>
- 350 MHz (MSO/DSO7032A), 200 mV<sub>pp</sub>

Trigger range = +/- 8 V

- 500 MHz (MSO/DSO7052A), 500 mV<sub>pp</sub>
- 350 MHz (MSO/DSO7032A), 500 mV<sub>pp</sub>



- 1 Connect the equipment (see [Figure 7](#)).
  - a Use the N cable to connect the signal generator to the power splitter input.
  - b Connect one output of the power splitter to the Ext Trigger input.
  - c Connect the power sensor to the other output of the power splitter.

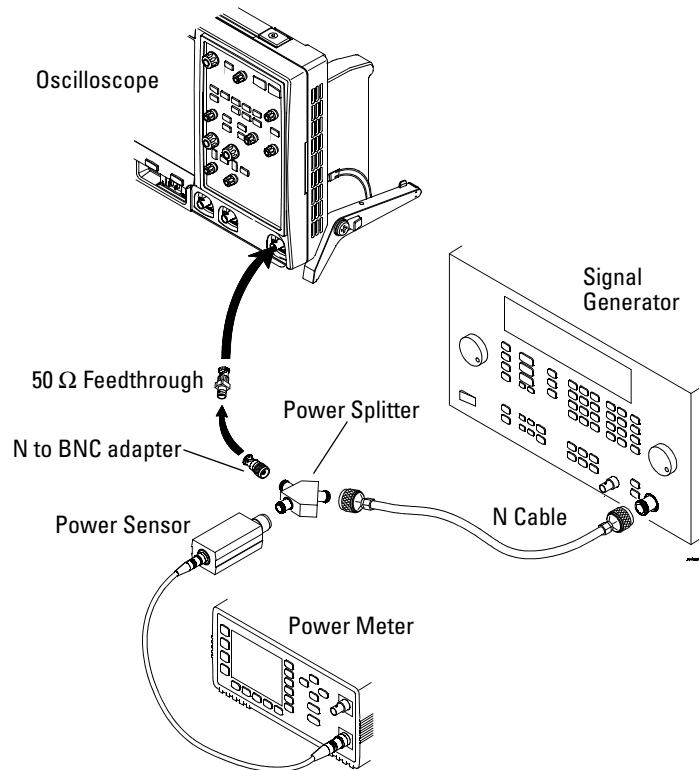

**Figure 7** Setting Up Equipment for 2-Channel External Trigger Sensitivity Test

- 2 Set up the oscilloscope.
  - a Press the **Save/Recall** key, then press the **Default Setup** softkey.
  - b Set the External Trigger impedance to **50 Ohm**.
  - c Change the trigger **Mode** from Auto to **Normal**.
  - d Use the **Range** softkey and the Entry knob to set the range to 1.0 V.
- 3 Verify the trigger sensitivity at maximum frequency.
  - a Change the signal generator output frequency:  
MSO/DSO7052A: 500 MHz  
MSO/DSO7032A: 350 MHz
  - b Set the power meter Cal Factor % to the appropriate value (350 or 500 MHz) on the calibration chart on the power sensor. If necessary, do a linear interpolation if the correct factor is not included in the power meter's calibration chart.
  - c Adjust the signal generator output for a reading on the power meter of 100 $\mu$ W. (200 mV<sub>pp</sub> = 70.71mV rms, Power =  $V_{in}^2/50\Omega = 70.71 \text{ mV}^2/50\Omega = 100\mu\text{W}$ .)
  - d Press the Trigger **Edge** key, then press the **Source** softkey to set the trigger source to external trigger.
  - e Check for stable triggering and adjust the trigger level if necessary. Triggering is indicated by the **Trig'd** indicator at the top of the display. When it is flashing, the oscilloscope is not triggered. When it is not flashing, the oscilloscope is triggered.
  - f Record the results as Pass or Fail in the Performance Test Record (see [page 54](#)).

If the test fails, see the "Troubleshooting" chapter. Then return here.

- 4 Verify the trigger sensitivity at maximum frequency for trigger range of 8.0 V.
  - a Press the **Mode/Coupling** key, press the **External** softkey, then press the **Range** softkey and use the Entry knob to set the range to 8.0 V.
  - b Adjust the signal generator output for reading on the power meter of  $625\mu\text{W}$ . ( $500\text{mV}_{\text{pp}} = 176.78\text{mV rms}$ ,  
 $\text{Power} = V_{\text{in}}^2/50\Omega = 176.78\text{ mV}^2/50\Omega = 625\mu\text{W}$ .)
  - c Check for stable triggering and adjust the trigger level if necessary. Triggering is indicated by the **Trig'd** indicator at the top of the display. When it is flashing, the oscilloscope is not triggered. When it is not flashing, the oscilloscope is triggered.
  - d Record the results as Pass or Fail in the Performance Test Record (see [page 54](#)).

## Test External Trigger Sensitivity (4-channel models)

This test applies to 4-channel models only.

Verify the external trigger sensitivity at these settings:

- 1 GHz, 500 MHz, and 350 MHz bandwidth models:  
500 MHz, 500 mV<sub>pp</sub>

## 2 Testing Performance

- 1 Connect the equipment (see Figure 8).
  - a Use the N cable to connect the signal generator to the power splitter input.
  - b Connect one output of the power splitter to the Aux Trig input through a 50 $\Omega$  feedthrough termination.
  - c Connect the power sensor to the other output of the power splitter.

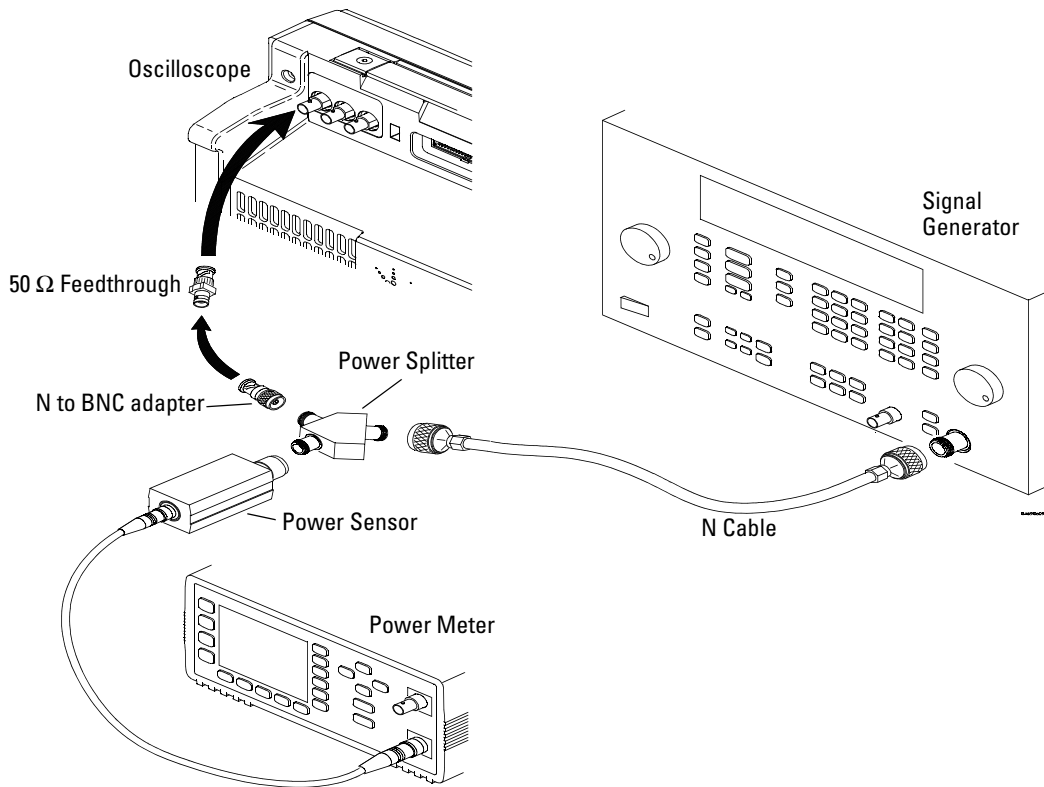

**Figure 8** Setting Up Equipment for 4-Channel External Trigger Sensitivity Test

- 2 Set up the oscilloscope.
  - a Press the **Save/Recall** key, then press the **Default Setup** softkey.
- 3 Change the signal generator output frequency to 500 MHz.
- 4 Set the power meter Cal Factor % to the appropriate value (500 MHz) on the calibration chart on the power sensor. If necessary, do a linear interpolation if a 500 MHz factor is not included in the power meter's calibration chart.
- 5 Adjust the signal generator output for reading on the power meter of  $625\mu\text{W}$ . ( $500\text{mV}_{\text{pp}} = 176.78\text{mV rms}$ ,  
 $\text{Power} = V_{\text{in}}^2/50\Omega = 176.78\text{ mV}^2/50\Omega = 625\mu\text{W}$ .)
- 6 Press the Trigger **Edge** key, then press the **Source** softkey to set the trigger source to **External**.
- 7 Check for stable triggering and adjust the trigger level if necessary. Triggering is indicated by the **Trig'd** indicator at the top of the display. When it is flashing, the oscilloscope is not triggered. When it is not flashing, the oscilloscope is triggered.
- 8 Record the results as Pass or Fail in the Performance Test Record (see [page 54](#)).

If the test fails, see the "Troubleshooting" chapter. Then return here.

## Agilent 7000 Series Oscilloscopes Performance Test Record

Serial No. _____		Test by _____	
Test Interval _____		Work Order No. _____	
Recommended Next Testing _____		Temperature _____	
<b>Threshold Accuracy Test (100 mV + 3% of threshold setting)</b>	<b>Specification</b>	<b>Limits</b>	<b>Ch D7-D0 Ch D15-D8</b>
	5 V - 250 mV	4.750 V	_____
	5 V + 250 mV	5.250 V	_____
	-5 V - 250 mV	-5.250 V	_____
	-5 V + 250 mV	-4.750 V	_____
	0 V - 100 mV	-100 mV	_____
	0 V + 100 mV	100 mV	_____
<b>Voltage Measurement Accuracy</b>			
<b>Range</b>	<b>Power Supply Setting</b>	<b>Test Limits</b>	<b>Channel 1 Channel 2 Channel 3* Channel 4*</b>
5 V/Div	35 V	34.04 V to 35.96 V	_____
2 V/Div	14 V	13.616 V to 14.384 V	_____
1 V/Div	7 V	6.808 V to 7.192 V	_____
500 mV/Div	3.5 V	3.404 V to 3.596 V	_____
200 mV/Div	1.4 V	1.3616 V to 1.4384 V	_____
100 mV/Div	700 mV	680.8 mV to 719.2 mV	_____
50 mV/Div	350 mV	340.4 mV to 359.6 mV	_____
20 mV/Div	140 mV	136.16 mV to 143.84 mV	_____
10 mV/Div	70 mV	68.08 mV to 71.92 mV	_____
5 mV/Div	35 mV	34.04 mV to 35.96 mV	_____
2 mV/Div	14 mV	13.232 mV to 14.768 mV	_____
<b>Bandwidth</b>	<b>Model</b>	<b>Test Limits</b>	<b>Channel 1 Channel 2 Channel 3* Channel 4*</b>
	710x	3 dB at 1 GHz	_____
	705x	3 dB at 500 MHz	_____
	703x	3 dB at 350 MHz	_____
<b>Horizontal <math>\Delta t</math> Accuracy</b>			
	<b>Generator Setting</b>	<b>Test Limits</b>	<b>Results</b>
Period	100 $\mu$ s	99.8 $\mu$ s to 100.2 $\mu$ s	_____
Period	100 ns	99.8 ns to 100.2 ns	_____
Period	5 ns	4.96 ns to 5.04 ns	_____
<b>Trigger Sensitivity</b>		<b>Test Limits</b>	<b>Channel 1 Channel 2 Channel 3* Channel 4*</b>
	Internal trigger	1 division at 25 MHz	_____
	1 GHz models	0.6 division at 1 GHz	_____
	500 MHz models	0.6 division at 500 MHz	_____
	350 MHz models	0.6 division at 350 MHz	_____

Performance Test Record is continued on next page.

Trigger Sensitivity	Test Limits	Channel 1	Channel 2	Channel 3*	Channel 4*
External trigger (7052A, 7032A) ± 1 V range:					
	100 mV at 25 MHz	_____	_____	_____	_____
7052A	200 mV at 500 MHz	_____	_____	_____	_____
7032A	200 mV at 350 MHz	_____	_____	_____	_____
External trigger (7052A, 7032A) ± 8 V range:					
	250 mV at 25 MHz	_____	_____	_____	_____
7052A	500 mV at 500 MHz	_____	_____	_____	_____
7032A	500 mV at 350 MHz	_____	_____	_____	_____
External trigger (7104A, 7054A, 7034A)	500 mV at 500 MHz	_____	_____	_____	_____

\* Where applicable

## 2 Testing Performance



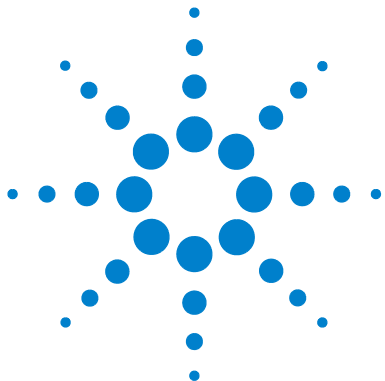

## 3 Calibrating and Adjusting

This chapter explains how to adjust the oscilloscope for optimum operating performance. You should perform self-calibration according to the following recommendations:

- Every 12 months or after 2000 hours of operation
- If the ambient temperature is  $>10$  °C from the calibration temperature
- If you want to maximize the measurement accuracy

The amount of use, environmental conditions, and experience with other instruments help determine if you need shorter adjustment intervals.

### Let the Equipment Warm Up Before Adjusting

Before you start the adjustments, let the oscilloscope and test equipment warm up for at least 30 minutes.

### Read All Cautions and Warnings

Read the following cautions and warning before making adjustments or performing self-calibration.

#### WARNING

##### HAZARDOUS VOLTAGES!

Read the safety notice at the front of this book before proceeding. Maintenance is performed with power supplied to the oscilloscope and with the protective covers removed. Only trained service personnel who are aware of the hazards involved should perform the maintenance. Whenever possible, perform the procedures with the power cord removed from the oscilloscope.

#### CAUTION

##### REMOVE POWER TO AVOID DAMAGE!

Do not disconnect any cables or remove any assemblies with power applied to the oscilloscope. Otherwise, damage to the oscilloscope can occur.



#### CAUTION

##### **USE EXTERNAL FAN TO REDUCE TEMPERATURE!**

When you must operate the oscilloscope with its cover and main shield removed, use an external fan to provide continuous air flow over the samplers (the ICs with heat sinks on them). Air flow over the samplers is reduced when the cover and main shield is removed, which leads to higher than normal operating temperatures. Have the fan blow air across the system board where the heat sinks are located. If the cover is removed but the main shield remains installed and the bottom holes are not blocked, the instrument will cool properly.

---

#### CAUTION

##### **AVOID DAMAGE TO ELECTRONIC COMPONENTS!**

Electrostatic discharge (ESD) can damage electronic components. When you use any of the procedures in this chapter, use proper ESD precautions. As a minimum, place the oscilloscope on a properly grounded ESD mat and wear a properly grounded ESD strap.

---

## User Calibration

Perform user-calibration:

- Each year or after 2000 hours of operation.
- If the ambient temperature is  $>10^{\circ}$  C from the calibration temperature.
- If you want to maximize the measurement accuracy.

The amount of use, environmental conditions, and experience with other instruments help determine if you need shorter User Cal intervals.

User Cal performs an internal self-alignment routine to optimize the signal path in the oscilloscope. The routine uses internally generated signals to optimize circuits that affect channel sensitivity, offset, and trigger parameters. Disconnect all inputs and allow the oscilloscope to warm up before performing this procedure.

Performing User Cal will invalidate your Certificate of Calibration. If NIST (National Institute of Standards and Technology) traceability is required perform the procedures in [Chapter 2](#) in this book using traceable sources.

### To perform User Cal

- 1 Set the rear-panel CALIBRATION switch to UNPROTECTED.
- 2 Connect short (12 inch maximum) equal length cables to each analog channel's BNC connector on the front of the oscilloscope. You will need two equal-length cables for a 2-channel oscilloscope or four equal-length cables for a 4-channel oscilloscope.

### 3 Calibrating and Adjusting

Use 50 $\Omega$  RG58AU or equivalent BNC cables when performing User Cal.

- a For a 2-channel oscilloscope, connect a BNC tee to the equal length cables. Then connect a BNC(f)-to-BNC(f) (also called a barrel connector) to the tee as shown below.

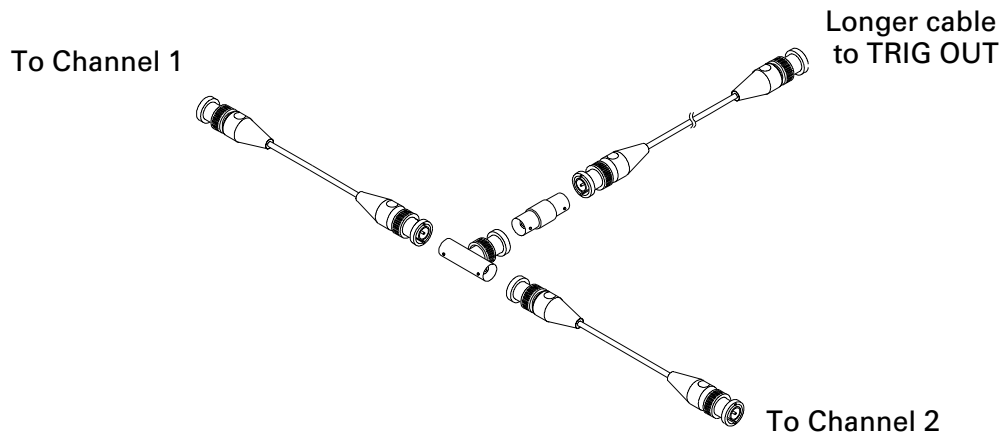

**Figure 9** User Calibration cable for 2-channel oscilloscope

- b For a 4-channel oscilloscope, connect BNC tees to the equal-length cables as shown below. Then connect a

BNC(f)-to-BNC(f) (barrel connector) to the tee as shown below.

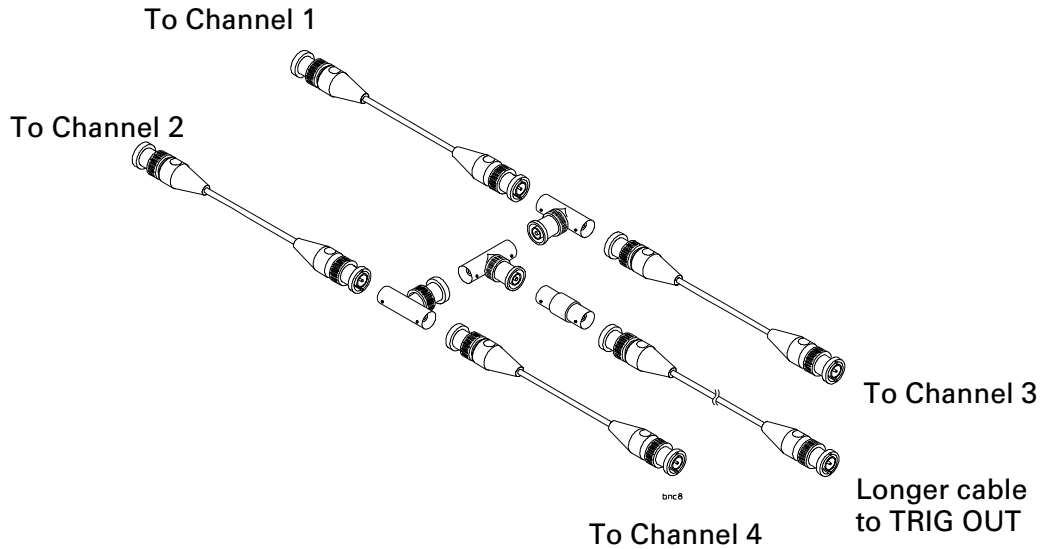

**Figure 10** User Calibration cable for 4-channel oscilloscope

- 3** Connect a BNC cable (40 inches maximum) from the TRIG OUT connector on the rear panel to the BNC barrel connector.
- 4** Press the **Utility** key, then press the **Service** softkey.
- 5** Begin the Self Cal by pressing the **Start User Cal** softkey.
- 6** When the User Cal is completed, set the rear-panel CALIBRATION switch to PROTECTED.

## User Cal Status

Pressing the **User Cal Status** softkey displays the following summary results of the previous User Cal, and the status of probe calibrations for probes that can be calibrated. Note that AutoProbes do not need to be calibrated, but InfiniiMax probes can be calibrated.

Results:

User Cal date:

Change in temperature since last User Cal:

Failure:

Comments:

Probe Cal Status:



## 4 Troubleshooting

This chapter begins with suggestions for solving general problems that you may encounter with the oscilloscope. It tells you what to do in these cases:

- If there is no trace display
- If the trace display is unusual or unexpected
- If you cannot see a channel
- If you cannot get any response from the oscilloscope

Procedures for troubleshooting the oscilloscope follow the problem solving suggestions. The troubleshooting section shows you how to:

- Check out the oscilloscope
- Check power supply
- Check the system board
- Check the display
- Check the fan
- Run internal self-tests
- Verify default setup

**Read All Cautions and Warnings**

Before you begin any troubleshooting, read all Warning and Cautions in the “Troubleshooting” section.



## Solving General Problems with the Oscilloscope

This section describes how to solve general problems that you may encounter while using the Agilent 7000 Series Oscilloscopes to make measurements.

After troubleshooting the oscilloscope, if you need to replace parts, refer to the “Replaceable Parts” chapter.

### If there is no display

- ✓ Check that the power cord is firmly seated in the oscilloscope power receptacle.
- ✓ Check that the power source is live.
- ✓ Check that the front-panel power switch is on.
- ✓ If there is still no display, go to the troubleshooting procedures in this chapter.

### If there is no trace display

- ✓ Check that the INTENSITY knob on the front panel is adjusted correctly.
- ✓ Recall the default setup by pressing **Save/Recall** then **Default Setup**. This will ensure that the trigger mode is Auto.
- ✓ Check that the probe clips are securely connected to points in the circuit under test, and that the ground is connected.
- ✓ Check that the circuit under test is powered on.
- ✓ Press the **AutoScale** key.
- ✓ Obtain service from Agilent Technologies, if necessary.

### If the trace display is unusual or unexpected

- ✓ Check that the Horizontal time/division setting is correct for the expected frequency range of the input signals.



- ✓ The sampling speed of the oscilloscope depends on the time/division setting. It may be that when time/division is set to slower speeds, the oscilloscope is sampling too slowly to capture all of the transitions on the waveform. Use peak detect mode.
- ✓ Check that all oscilloscope probes are connected to the correct signals in the circuit under test.
- ✓ Ensure that the probe's ground lead is securely connected to a ground point in the circuit under test. For high-speed measurements, each probe's individual ground lead should also be connected to a ground point closest to the signal point in the circuit under test.
- ✓ Check that the trigger setup is correct.
- ✓ A correct trigger setup is the most important factor in helping you capture the data you desire. See the User's Guide for information about triggering.
- ✓ Check that infinite persistence in the Display menu is turned off, then press the **Clear Display** softkey.
- ✓ Press the **AutoScale** key.

#### **If you cannot see a channel**

- ✓ Recall the default setup by pressing **Save/Recall** then **Default Setup**. This will ensure that the trigger mode is Auto.
- ✓ Check that the oscilloscope probe's BNC connector is securely attached to the oscilloscope's input connector.
- ✓ Check that the probe clips are securely connected to points in the circuit under test.
- ✓ Check that the circuit under test is powered on.

You may have pressed the **AutoScale** key before an input signal was available.

Performing the checks listed here ensures that the signals from the circuit under test will be seen by the oscilloscope. Perform the remaining checks in this topic to make sure the oscilloscope channels are on, and to obtain an automatic setup.

- ✓ Check that the desired oscilloscope channels are turned on.
  - a Press the analog channel key until it is illuminated.
  - b On models with the MSO option, press the digital channels (**D15-D0**) key until it is illuminated.
- ✓ Press the **AutoScale** key to automatically set up all channels.

## Troubleshooting the Oscilloscope

The service policy for the Agilent 7000 Series Oscilloscopes is assembly level replacement. If you need parts or assistance from Agilent Technologies to repair your instrument, go to [www.agilent.com](http://www.agilent.com) and locate the service facility for your area.

**WARNING****HAZARDOUS VOLTAGES EXIST — REMOVE POWER FIRST !**

The procedures described in this section are performed with power supplied to the oscilloscope and with the protective covers removed. Only trained service personnel who are aware of the hazards involved should perform the procedures. Whenever possible, perform the procedures with the power cord removed from the oscilloscope. Read the safety notice at the back of this book before proceeding.

---

**WARNING****HAZARDOUS VOLTAGES EXIST — HIGH VOLTAGE IS PRESENT ON POWER SUPPLY HEAT SINKS !**

The power supply heat sinks of the 7000 Series oscilloscopes are at a high potential. This presents an electric shock hazard. Protect yourself from electric shock by keeping this area covered or by not coming in contact with the heat sinks when the power cord is attached to the oscilloscope!

---

**CAUTION****REMOVE POWER TO AVOID DAMAGE !**

Do not disconnect any cables or remove any assemblies while power is applied to the oscilloscope, or damage to the oscilloscope can occur.

---

**CAUTION****AVOID ESD DAMAGE TO COMPONENTS !**

ELECTROSTATIC DISCHARGE (ESD) can damage electronic components. Use proper ESD precautions when doing any of the procedures in this chapter. As a minimum, place the oscilloscope on a properly grounded ESD mat and wear a properly grounded ESD strap.

---

## Equipment required for troubleshooting

The equipment listed in this table is required to troubleshoot the oscilloscope.

**Table 11** Equipment Required to Troubleshoot the Oscilloscope

Equipment	Critical Specifications	Recommended Model/Part
Digital multimeter	Accuracy $\pm 0.05\%$ , 1 mV resolution	Agilent 34401A
Oscilloscope	Capable of measuring $\geq 500$ MHz signal. 1 M $\Omega$ input impedance.	Agilent DS06102A, MS06102A, DS07104A, or MS07104A

## To check out the oscilloscope

- 1 Disconnect any external cables from the front panel.
- 2 Disconnect the power cord, then remove the cabinet following the instructions on [page 81](#).

### CAUTION

#### USE AN EXTERNAL FAN TO AVOID OVERHEATING COMPONENTS !

When you remove the oscilloscope cover and main shield, use an external fan to provide continuous air flow over the heat sinks. Air flow over the heat sinks is reduced when the cover and main shield are removed, which leads to higher than normal operating temperatures. Have the fan blow air across the system board where the heat sinks are located. Otherwise, damage to the components can occur.

If the cover of a 7000A Series oscilloscope is removed but the main shield remains installed and the bottom holes are not blocked, the instrument will cool properly.

### WARNING



#### HAZARDOUS VOLTAGES EXIST — HIGH VOLTAGE IS PRESENT ON POWER SUPPLY HEAT SINKS !

The power supply heat sinks of the oscilloscope are at a high potential. This presents an electric shock hazard. Protect yourself from electric shock by keeping this area covered or by not coming in contact with the heat sinks when the power cord is attached to the oscilloscope!

- 3 Connect the power cord to the rear of the oscilloscope, then to a suitable ac voltage source.

The oscilloscope power supply automatically adjusts for input line voltages in the range of 100 to 240 VAC. Ensure that you have the correct line cord (see [page 103](#)). The power cord provided is matched to the country of origin.

**WARNING****AVOID INJURY.**

Always operate the oscilloscope with an approved three conductor power cable. Do not negate the protective action of the three conductor power cable.

---

- Press the power switch.
    - When the oscilloscope is turned on, the front panel LEDs will briefly light up in groups from bottom to top.
    - Next the Agilent logo appear on the display.
    - Next a message will appear with tips on getting started using the oscilloscope. At this time you can press any key to remove the message and view the display. Or you can wait and the message will automatically disappear.
    - It will take a total of about 10-15 seconds for the oscilloscope to go through its basic self test and power-up routine.
- 4 Proceed to [“To verify basic oscilloscope operation”](#) on page 70.

## To verify basic oscilloscope operation

- 1 Press the **Save/Recall** key on the front panel, then press the **Default Setup** softkey under the display. The oscilloscope is now configured to its default settings.
- 2 Connect an oscilloscope probe from channel 1 to the **Probe Comp** signal terminal on the front panel.
- 3 Connect the probe's ground lead to the ground terminal that is next to the **Probe Comp** terminal.
- 4 Press **AutoScale**.
- 5 You should see a waveform on the oscilloscope's display similar to this:

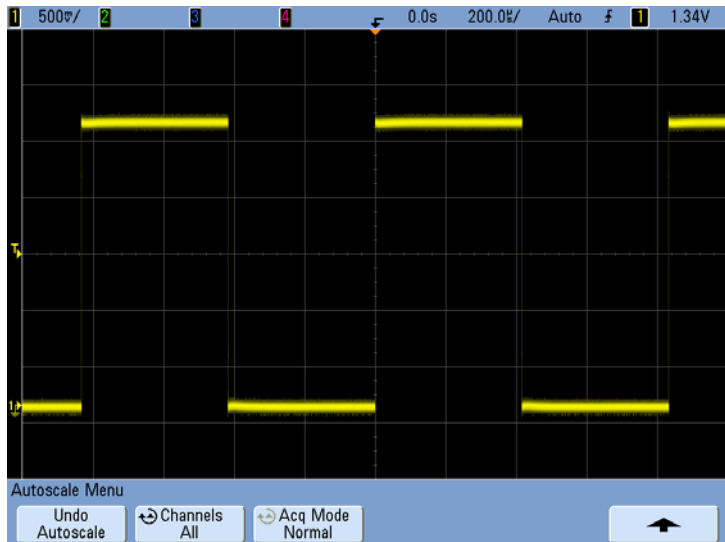

If you see the waveform, but the square wave is not shaped correctly as shown above, perform the procedure [“To compensate the analog probes”](#) on page 71.

If you do not see the waveform, ensure your power source is adequate, the oscilloscope is properly powered-on, and the probe is connected securely to the front-panel analog channel input BNC and to the Probe Comp terminal.

- 6 If you still do not see the waveform, use the troubleshooting flowchart in this chapter to isolate the problem.

## To compensate the analog probes

You should compensate your analog probes to match their characteristics to the oscilloscope's channels. A poorly compensated probe can introduce measurement errors.

- 1 Perform the procedure “[To verify basic oscilloscope operation](#)” on page 70
- 2 Use a nonmetallic tool to adjust the trimmer capacitor on the probe for the flattest pulse possible. The trimmer capacitor is located on the probe BNC connector.

**Perfectly compensated**

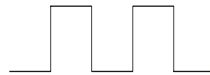

**Over compensated**



**Under compensated**



comp.cdr

**Figure 11** Example pulses

- 3 Connect probes to all other analog channels (channel 2 of a 2-channel oscilloscope, or channels 2, 3, and 4 of a 4-channel oscilloscope). Repeat the procedure for each channel. This matches each probe to each channel.

The process of compensating the probes serves as a basic test to verify that the oscilloscope is functional.

## Troubleshooting Flowchart

The following flowchart describes how to troubleshoot the oscilloscope.

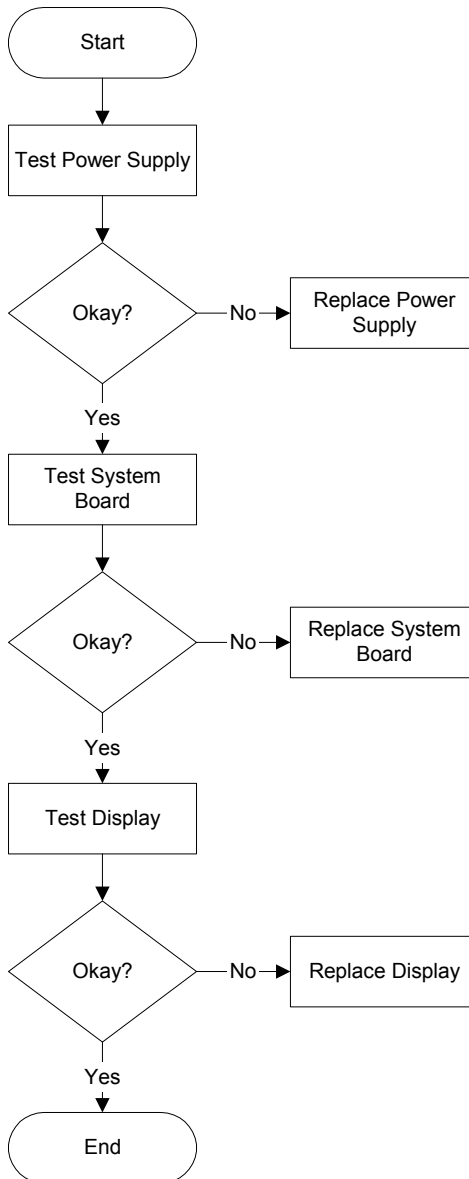







## To check the 7000A Series oscilloscope power supply

- 1 Disconnect the power cord from the oscilloscope. Then remove the oscilloscope cover.

### CAUTION

#### USE AN EXTERNAL FAN TO AVOID OVERHEATING COMPONENTS !

When you remove the oscilloscope cover and main shield, use an external fan to provide continuous air flow over the heat sinks. Air flow over the heat sinks is reduced when the cover and main shield are removed, which leads to higher than normal operating temperatures. Have the fan blow air across the system board where the heat sinks are located. Otherwise, damage to the components can occur.

If the cover of a 7000A Series oscilloscope is removed but the main shield remains installed and the bottom holes are not blocked, the instrument will cool properly.

- 2 Connect the negative lead of the multimeter to a ground point on the oscilloscope.
- 3 Connect the power cord and turn on the oscilloscope.
- 4 Measure the power supply voltage at J3200, pin 9 on the system board. See [Figure 12](#) on page 73. The voltage should be  $15\text{ V} \pm 10\%$ .
  - If the voltage is not correct, continue to the next step.
  - If the voltage is correct, the power supply is good.
- 5 Disconnect the cable from the system board and check the voltage between pins 9 & 5 of the connector coming from the power supply.
- 6 If it is less than 14 V, the problem is in the cable or the power supply. Remove the cable and test it for shorts or opens using the DMM. Replace the defective assembly.
- 7 If the voltage is  $15\text{ V} \pm 10\%$  only when the cable is disconnected from the system board, then test the system board.

## To check the 7000A Series system board

- 1 Remove the handle, tilt legs, and cabinet.
- 2 Check that all cable connections are securely connected from the system board to:
  - Power supply
  - Keyboard (7000A Series only)
  - Display (7000A Series only)
  - Inverter board (7000A Series only)
  - Fan
- 3 Verify the voltages at the system board test points listed in the table below. Refer to [Figure 12](#) on page 73 and [Figure 13](#) on page 74 to locate the test points.

**Table 12** Regulator Voltage Test Points

Test point	Voltage	Output from regulator:
L3204	3.3 (+- 0.1)	U3202
L3201	5.0 (+- 0.1)	U3202
L3301	1.5 (+- 0.1)	U3300
L3302	-5.2 (+- 0.1)	U3301

- 4 If the voltage at test point L3301 and/or L3302 is not within the specified range, replace the system board.
- 5 If the voltage at test point L3204 and/or L3201 is not correct:
  - Disconnect J2730 from the system board and measure pins 1 and 2 on the system board connector. This is the voltage to the display, and it should be 3.3V. If it is not, replace the system board. If the voltage is correct, replace the display.
  - Disconnect J2750 from the system board and measure pins 1, 2, and 3. This is the voltage to the inverter, and it should be 12.4 V. If it is not, replace the system board. If the voltage is correct, replace the display.

- 6 If all cables are properly connected and none of the previous tests confirm a failure on another assembly, replace the system board.

## To check the 7000A Series display

- 1 Disconnect the power cord.
- 2 Check to verify that the backlight inverter cable is connected.
- 3 Ensure the display LCD cable is connected.
- 4 Connect the power cord.
- 5 Use the DMM to check the Inverter Power voltage (see table below). Refer to [Figure 12](#) on page 73 and [Figure 13](#) on page 74 to locate the test points.
- 6 If the voltage is incorrect, replace the system board.
- 7 If the voltage is correct, use an oscilloscope to check the LCD clock (see table below).

**Table 13** Display Signals on the System Board

	Signal	Normal/Typical Result
<b>Inverter Power</b>	J2750 Pin 1, 2, or 3	12.4 V
<b>Video Signal</b>	J2730 Pin 14 and 15	62.5 MHz clock

- 8 If the clock signal is good, replace the LCD.
- 9 If the clock signal is absent, replace the system board.

## To check the fan

The fan speed is controlled by a circuit on the system board.

- 1 If the fan is running, perform the internal self-tests. Go to [“To run the internal self-tests”](#) on page 79.
- 2 If the fan is not running, it may be defective. Follow these steps:
  - a Disconnect the fan cable from the system board.
  - b Measure the fan voltage at the connector on the system board.

See the figure below for the location of the fan connector.

- c If the fan voltage is approximately +8.5 Vdc at room temperature, replace the fan. If the fan voltage is not approximately +8.5 Vdc, replace the system board.

The proper voltage range depending on temperature is between +6.0 Vdc to +11.5 Vdc.

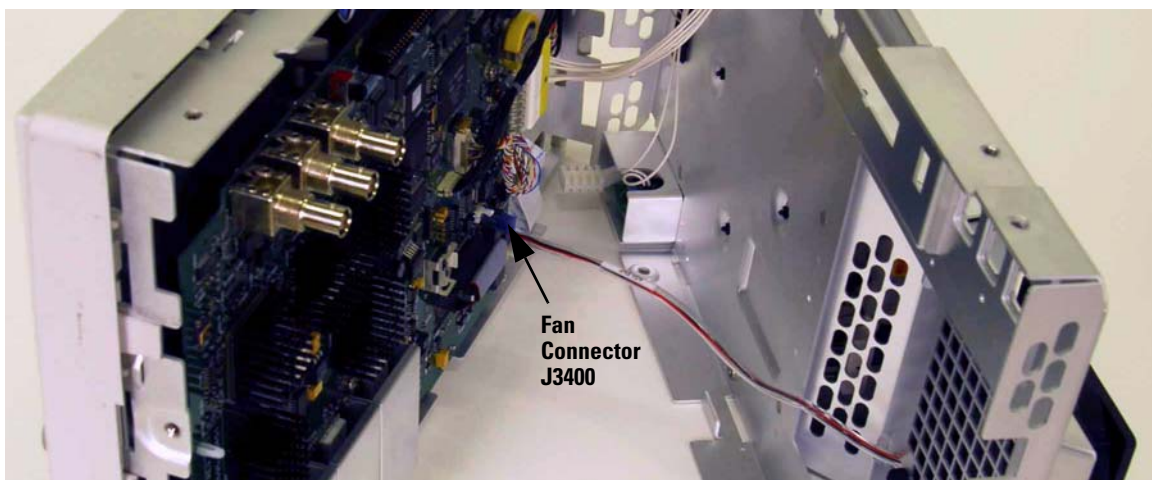

**Figure 14** Location of the Fan Connector

## To run the internal self-tests

Self Test performs a series of internal procedures to verify that the oscilloscope is operating properly.

It is recommended that you run the Self Test:

- after experiencing abnormal operation
- for additional information to better describe an oscilloscope failure
- to verify proper operation after the oscilloscope has been repaired

Successfully passing Self Test does not guarantee 100% of the oscilloscope's functionality. Self Test is designed to provide an 80% confidence level that the oscilloscope is operating properly.

- 1 Press the **Utility** key, then press the **Service** softkey.
- 2 Begin the internal self tests by pressing the **Start Self Test** softkey.

## To verify default setup

The oscilloscope is designed to turn on with the setup from the last turn on or previous setup. However, if the Secure Environment option is installed, the oscilloscope will always execute a Default Setup upon power-up.

To recall the factory default setup:

- 1 Press the **Save/Recall** key.
- 2 Press the **Default Setup** softkey.

This returns the oscilloscope to its factory default settings and places the oscilloscope in a known operating condition. The major default settings are:

- **Horizontal** - main mode, 100 us/div scale, 0 s delay, center time reference
- **Vertical** - Channel 1 on, 5 V/div scale, dc coupling, 0 V position, probe factor to 1.0 if an AutoProbe probe is not connected to the channel

## 4 Troubleshooting

- **Trigger** - Edge trigger, Auto sweep mode, 0 V level, channel 1 source, dc coupling, rising edge slope, 60 ns holdoff time
- **Display** - Vectors on, 33% grid intensity, infinite persistence off
- **Other** - Acquire mode normal, Run/Stop to Run, cursor measurements off



**Figure 15** Default setup screen

- 3 If your screen looks substantially different, replace the system board.





## 5 Replacing Assemblies

This chapter describes how to remove assemblies from the Agilent 7000A Series Oscilloscopes. To install a replacement assembly after you have removed an old one, follow the instructions in reverse order.

The parts shown in the following figures are representative and may look different from what you have in your oscilloscope.

### The removable assemblies include:

- Handle ([page 83](#))
- Adjustable Legs ([page 84](#))
- Cabinet ([page 85](#))
- Rear Deck ([page 86](#))
- Acquisition and Inverter Assemblies([page 88](#))
- Front Panel Assembly ([page 91](#))
- Fan Assembly ([page 97](#))
- Power Supply Shield ([page 98](#))
- Power Switch ([page 100](#))
- Power Supply ([page 100](#))
- AC Input Board ([page 101](#))

### Tools Used for Disassembly

Use these tools to remove and replace the oscilloscope assemblies:

- T6, T10, and T20 TORX drivers
- 5/8-inch and 9/32-inch socket drivers
- Flat head screw driver



### See how the Oscilloscope Parts Fit Together

An exploded view of the oscilloscope is included in the “Replaceable Parts” chapter. It shows the individual part numbers used in the assemblies, and shows you how the parts fit together.

### Read All Warnings and Cautions

Read the following warnings and cautions before removing and replacing any assemblies in the oscilloscope.

#### WARNING

##### HAZARDOUS VOLTAGES!

Read the safety summary at the back of this book before proceeding. Maintenance is performed with power supplied to the oscilloscope and with the protective covers removed. Only trained service personnel who are aware of the hazards involved should perform the maintenance. Whenever possible, perform the procedures with the power cord removed from the oscilloscope.

---

#### WARNING



##### AVOID ELECTRICAL SHOCK!

Hazardous voltages exist on the LCD assembly and power supply. To avoid electrical shock:

- 1 Disconnect the power cord from the oscilloscope.
- 2 Wait at least three minutes for the capacitors in the oscilloscope to discharge before you begin disassembly.

Read the Safety Summary at the back of this manual before you begin.

---

#### CAUTION

##### REMOVE POWER TO AVOID DAMAGE!

Remove power before you begin to remove and replace assemblies. Do not remove or replace assemblies while the oscilloscope is turned on, or damage to the components can occur.

---

#### CAUTION

##### AVOID DAMAGE TO ELECTRONIC COMPONENTS!

ELECTROSTATIC DISCHARGE (ESD) can damage electronic components. When doing any of the procedures in this chapter, use proper ESD precautions. As a minimum, you should place the instrument on a properly grounded ESD mat and wear a properly grounded ESD strap.

---

## Removing the Handle

The Strap Handle must be removed prior to removing the cabinet. The removal of the Strap handle may also be necessary when mounting oscilloscope in a rack.

- 1 Using T20 TORX driver, remove the screws holding strap handle caps in place.
- 2 Lift Strap handle off cabinet.

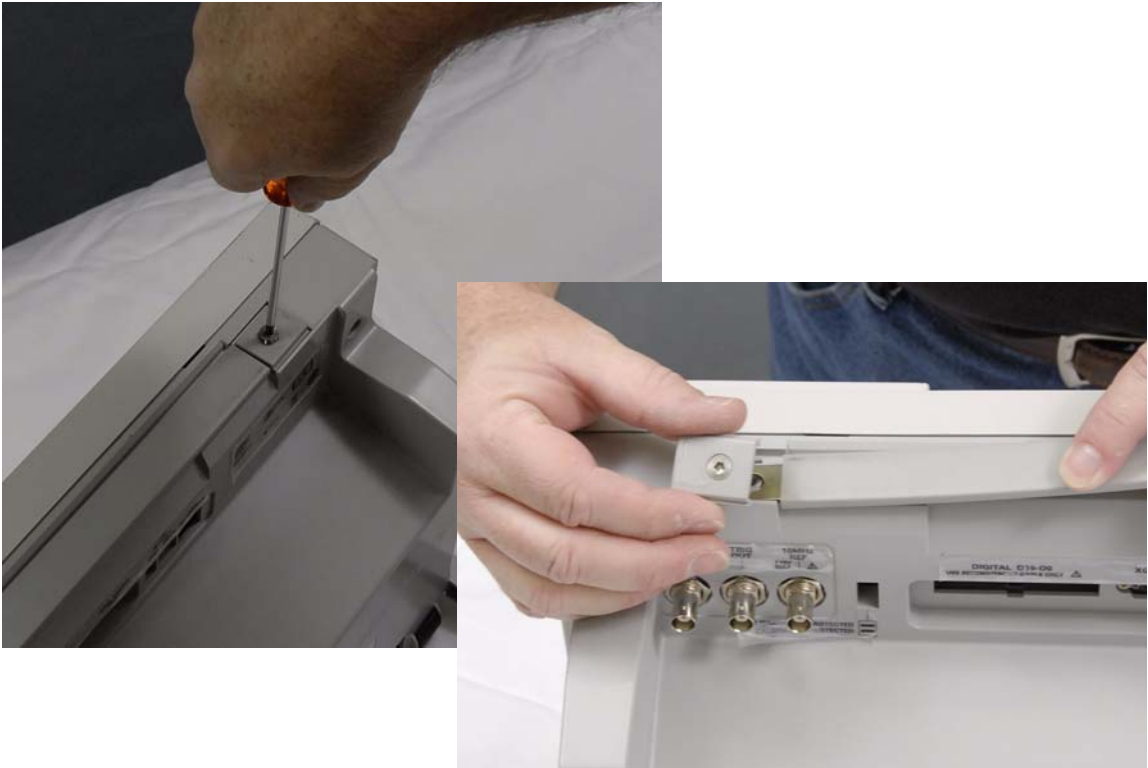

**Figure 16** Removing the handle

## To remove the Adjustable Legs

Adjustable legs must be removed prior to removing the cabinet.

- 1 Using a T20 TORX, remove shoulder screw and washer.
- 2 Pull adjustable leg assembly from cabinet. Assembly contains latching mechanism and spring.

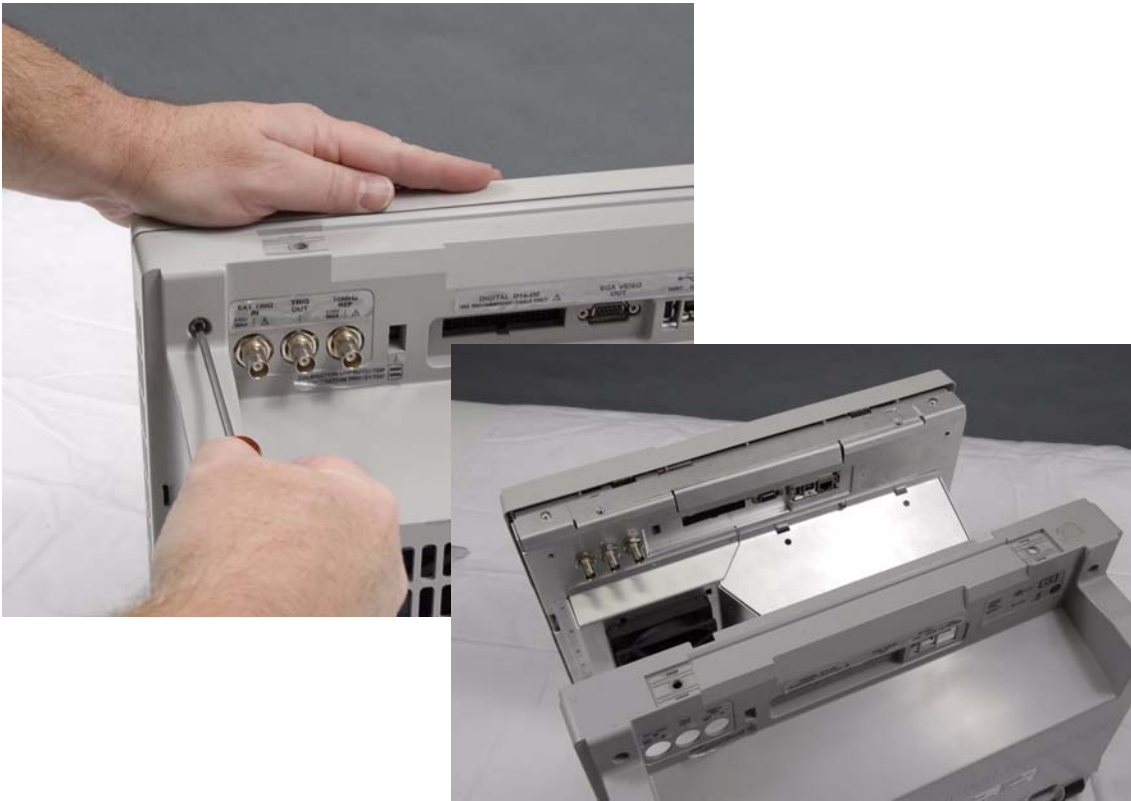

**Figure 17** Removing adjustable leg

## To remove Cabinet

Removing the cabinet allows access to the rear deck, fan assembly, power supply cover, power supply assembly, and power switch assembly.

- 1 Using T20 TORX, remove the three screws securing cabinet to rear deck assembly.
- 2 Carefully slide cabinet back away from rear deck assembly.



**Figure 18** Removing cabinet

## To remove the Rear Deck Assembly

Removing the rear deck allows access to the front deck, acquisition board, and inverter board.

- 1 Using a T20 TORX, locate and remove all screws securing rear deck to front deck.
- 2 Remove BNC securing nuts and washers.



**Figure 19** Removing the rear deck assembly

- 3 Carefully separate rear deck from front deck. Take care not damage extender switch.

**WARNING**

Sheet metal parts may have sharp edges. Handle with care to avoid injury.

- 4 Disconnect power harness and fan cable from acquisition board. Note cable locations for re-assembly

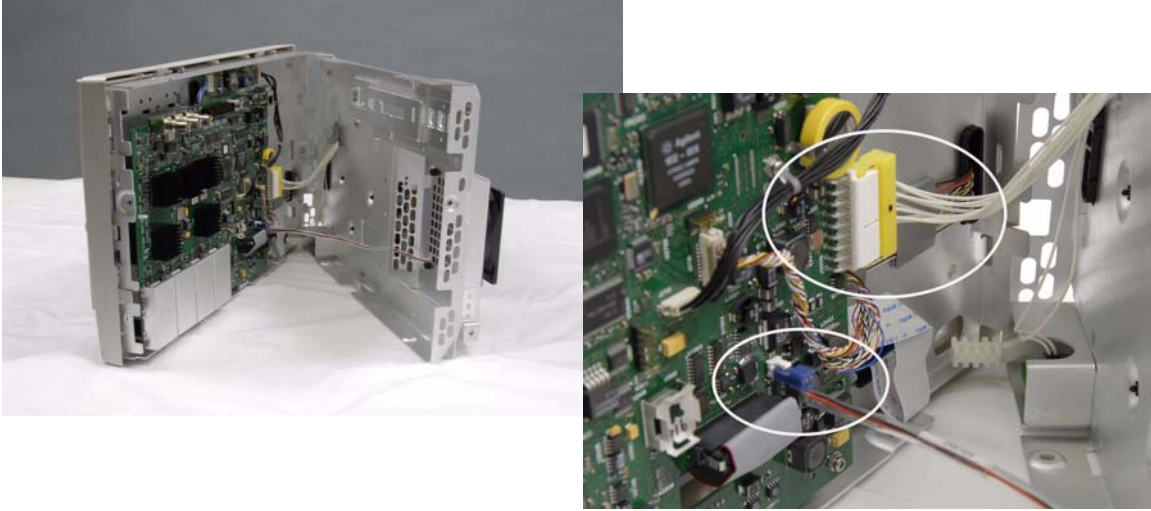

**Figure 20** Separating front and rear deck assemblies

## To remove Acquisition and Inverter assemblies

The following illustrates how to remove the Acquisition and Dual inverter printed circuit boards.

- 1 Using a TORX T6 driver locate and remove the 4 screws on the front of the instrument (4 Channel version).

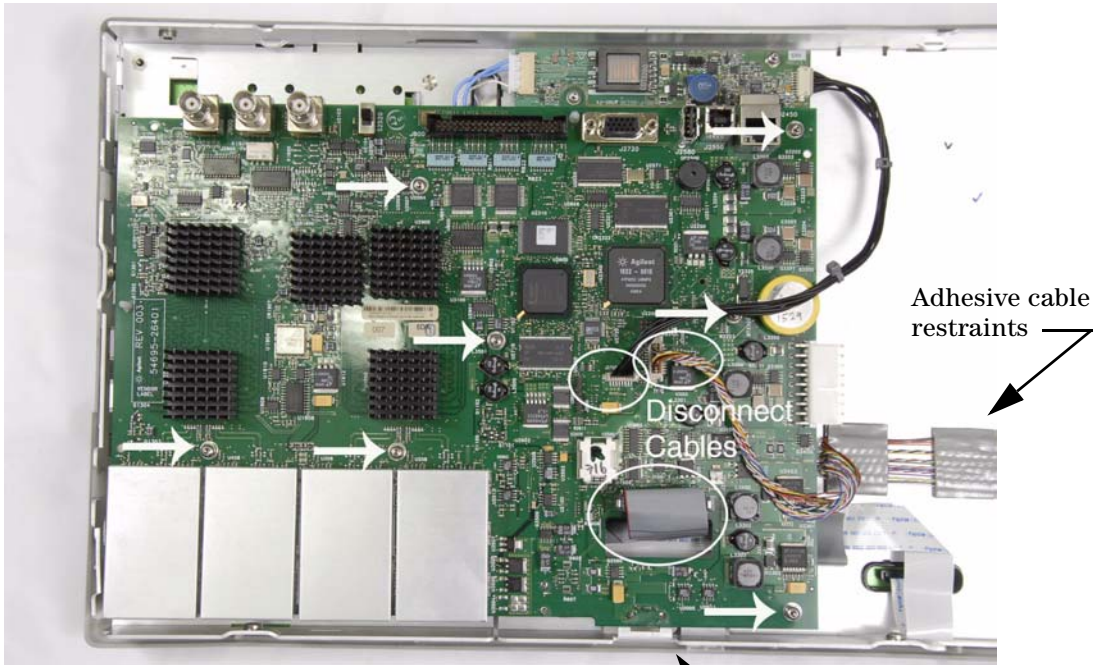

**Figure 21** Removing the T6 screws

- 2 Disconnect Inverter, keyboard and display cables. Note locations for re-connection. It should be noted that cables can be removed from cable clamps at this time as well. The cable restraining pads that affix the display cable to the front deck are adhesive and great care should be taken when removing them so as not to damage the cable.



- Using a TORX T10 driver locate and remove 7 mounting screws.



Note: when removing or replacing Acquisition board care should be taken so as not to damage grounding spring on front deck.

**Figure 22** TORX T10 mounting screw locations

## 5 Replacing Assemblies

- 4 Carefully unlock the two alignment pins. Carefully lift acquisition board off front deck.

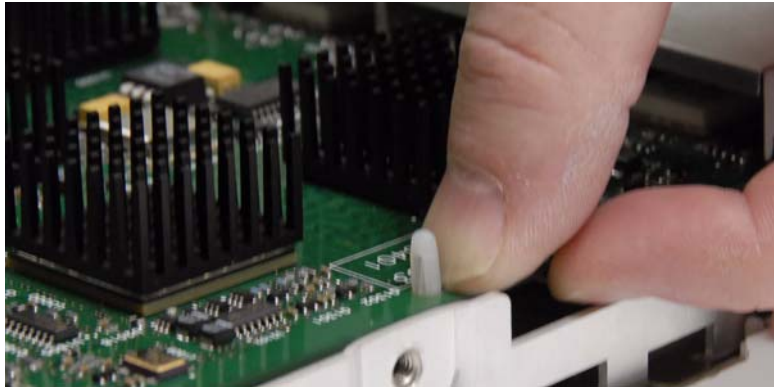

**Figure 23** Unlocking alignment pin

- 5 Using a TORX T10 driver locate and remove the two screws securing the Dual Inverter board to the front deck.
- 6 Disconnect all cables, lift board off front deck.



**Figure 24** Removal of inverter board

## To remove the Front Panel assembly

- 1 Remove cable shield from front deck. Carefully squeeze the shield so that it clears the sheet metal tabs holding it place then slide it free of the front deck:

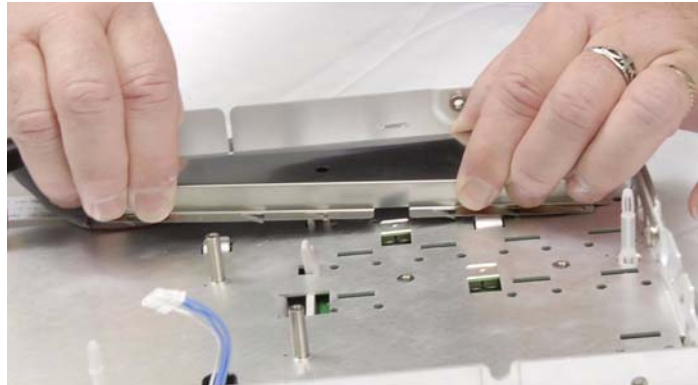
**WARNING**

Thin sheet metal parts may have sharp edges. Handle with care to avoid injury.

**Figure 25** Removing cable shield

- 2 Remove keyboard cables that extend thru front deck.

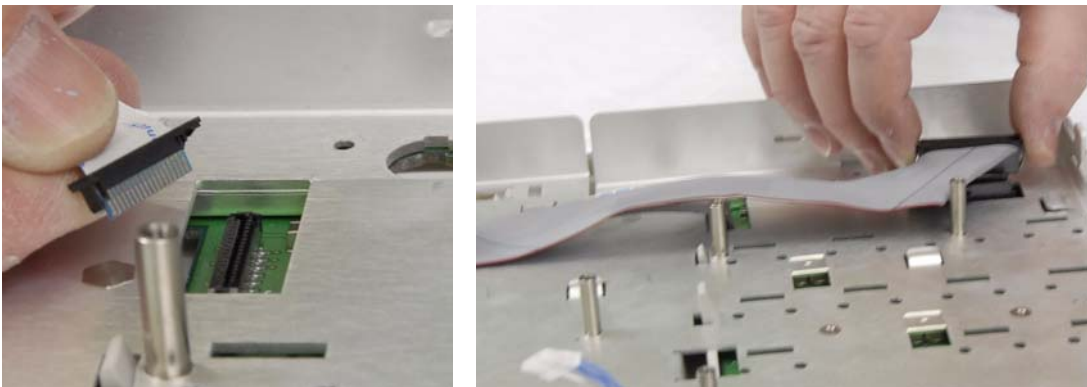

**Figure 26** Removing keyboard cables

- Carefully remove knobs from front panel. They may be gently pried loose with a flat head screw driver taking care not to scratch the faceplate, then pulled straight off.



**Figure 27** Removing knobs

- Remove bezel from front deck. Bezel is secured to front deck by molded-in retaining clips located around the perimeter of the bezel. Gently pry these outward (either by hand or using a flat head screwdriver). Working your way around the bezel releasing the clips gently lift the bezel away from the front deck.

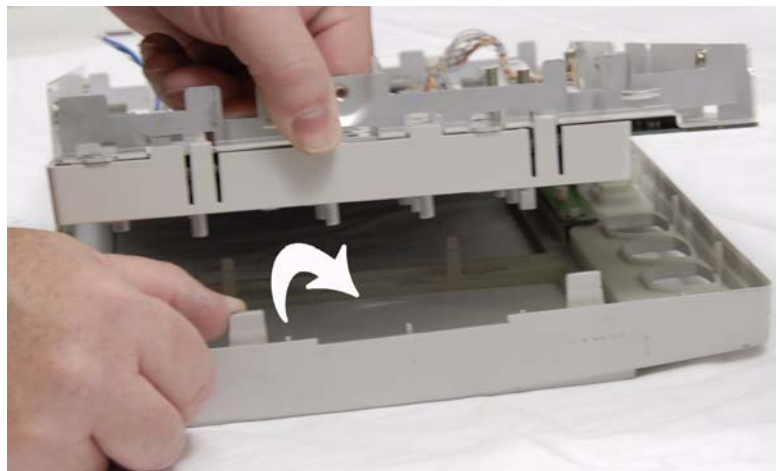

**Figure 28** Removing the bezel

- 5 To remove the Softkey board printed circuit board from the bezel, insure cable has been disconnected and slide board off alignment post.

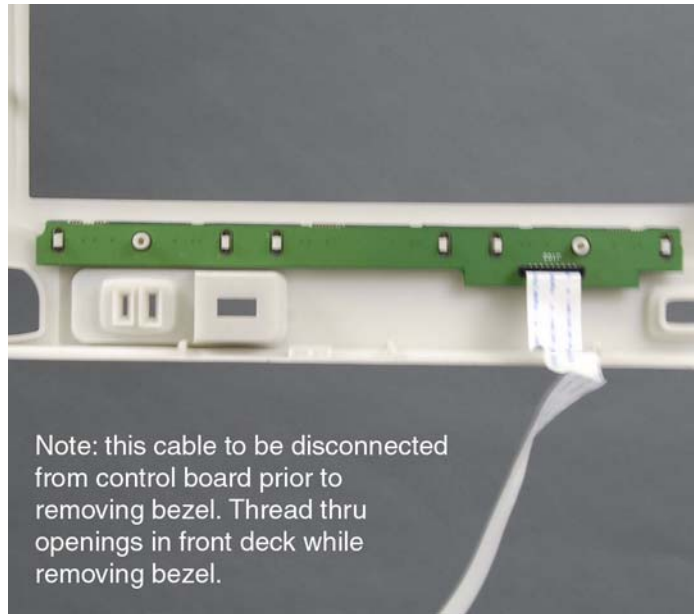
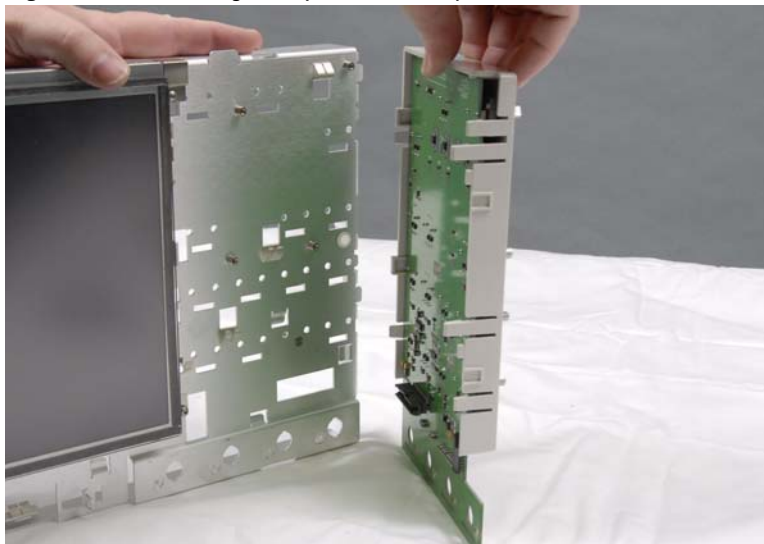

**Figure 29** Removal of softkey board

- 6 To remove the front panel assembly carefully release front panel clips that secure front panel assembly to the front deck by pulling them clear of the sheet metal tabs or openings.

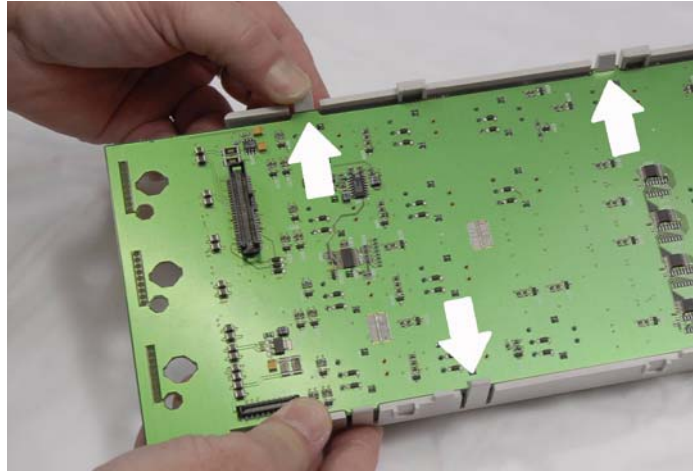

**Figure 30** Removing front panel assembly from front deck



**Figure 31** Front panel assembly separated from front deck

- 7 To separate the front panel control board from the front panel carefully pull back locking tabs that secure the front panel to the printed circuit board.



**Figure 32** Separating front panel from printed circuit board

- 8 Once front panel is removed assembly can be separated into individual components (control board, front panel and keypad).

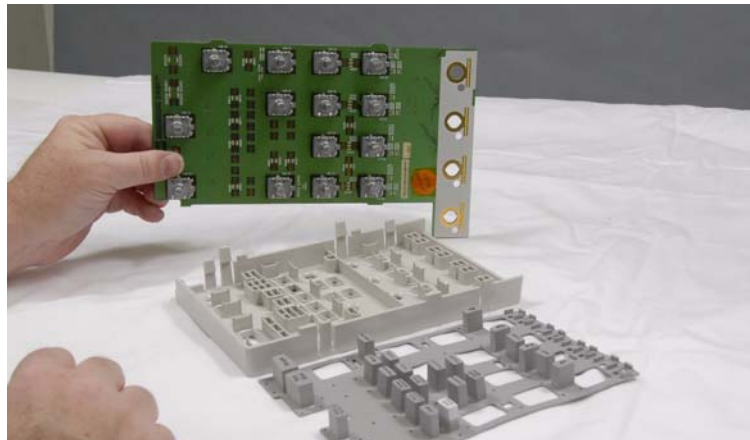

**Figure 33** Front panel disassembly

## 5 Replacing Assemblies

- 9 Using a TORX T10 remove the four screws that secure the display to the front deck. The upper right screw also secures the inverter cable shield. Take care while threading display cables thru front deck sheet metal openings. Display cable clips/strain reliefs must be disconnected prior to removing display assembly (see figure 22).



**Figure 34** Removing display assembly



## To remove the Fan assembly

- 1 Insure that fan power cable has been disconnected from Acquisition board.
- 2 Carefully slide fan assembly (fan and fan mount) to the right, then lift away from rear deck. Note, fan mount is soft and can be damaged by sharp sheet metal edges. Take care that the fan power cable is not damaged when pulling across sheet metal edges.



**Figure 35** Removing fan assembly

## To remove the power supply shield

- 1 To remove power supply shield, locate and remove using a TORX T20 the three screws securing the power supply cover to the rear deck.

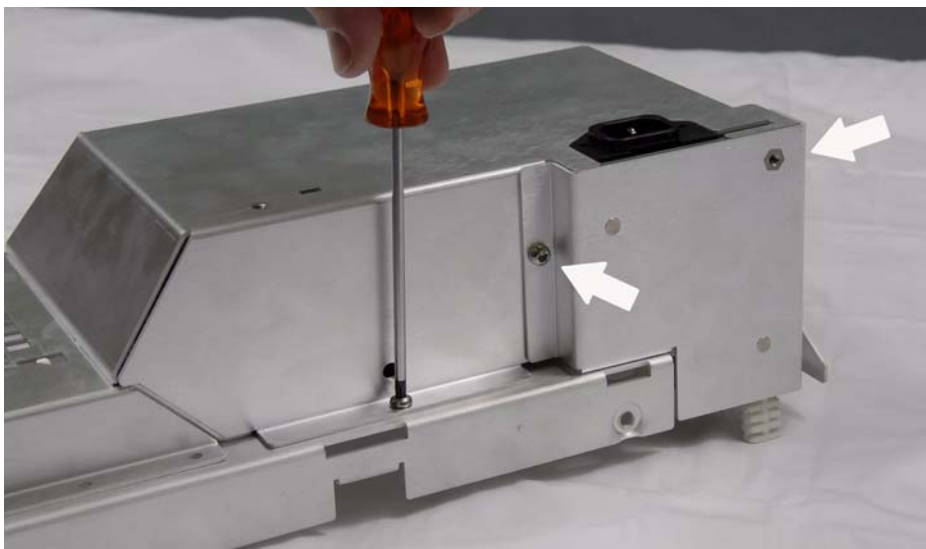

**Figure 36** Power supply cover screw removal

**WARNING**

Thin sheet metal parts may have sharp edges. Handle with care to avoid injury.

---

- 2 Once screws have been removed, carefully remove the power supply cover by lifting the cover up and off retaining tabs on rear deck.



**Figure 37** Lifting power supply cover off

## To remove the power supply

- 1 Disconnect all cables from power supply board.
- 2 Locate and remove using a TORX T10 driver the four screws securing the power supply assembly to the rear deck.



**Figure 38** Removing the power supply

## To remove the AC input board

- 1 Disconnect all cables on AC input board.
- 2 Locate and remove using a TORX T20 driver the single screw securing the assembly to the rear deck.
- 3 Slide assembly to right and lift out of rear deck.
- 4 Take care that you do not damage the switch extender during removal.

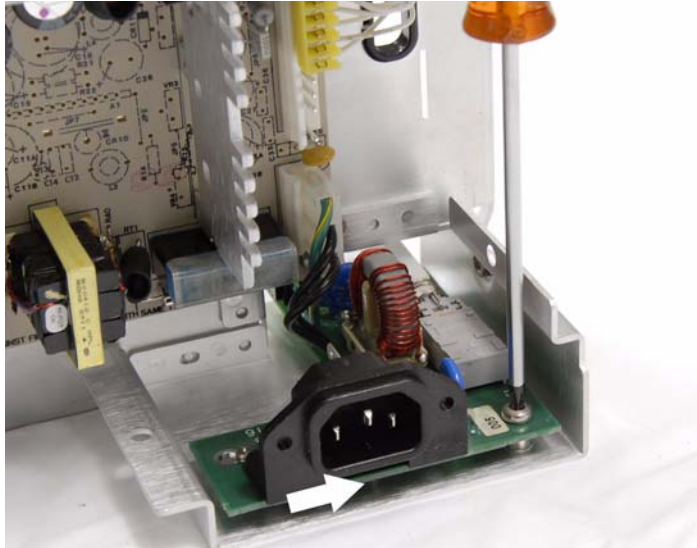

**Figure 39** Removing the AC input board

- 5 To remove the switch extender, gently pry open the extender using a flat head screwdriver.

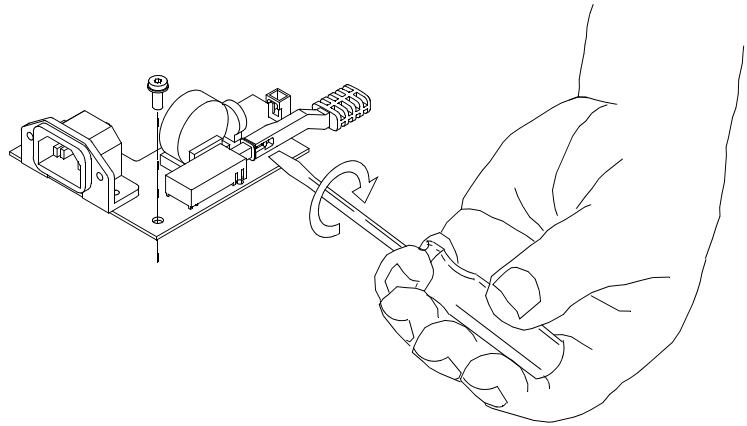

5-105-20

**Figure 40** Removing power switch extender

**CAUTION**

Twisting the latch too much could cause it to break!



## 6 Replaceable Parts

This chapter describes how to order replaceable assemblies and parts for the Agilent 7000A Series Oscilloscopes.

Diagrams and parts lists are included for assemblies and hardware that you can order.

Before working on the oscilloscope, read the safety summary at the back of this book.



## Ordering Replaceable Parts

### Listed Parts

To order a part in the parts list, quote the Agilent Technologies part number, indicate the quantity desired, and address the order to the nearest Agilent Technologies Sales Office. To find your nearest sales office go to **[www.agilent.com](http://www.agilent.com)**.

### Unlisted Parts

To order a part not listed in the parts list, include the instrument part number, instrument serial number, a description of the part (including its function), and the number of parts required. Address the order to the nearest Agilent Technologies Sales Office.

### Direct Mail Order System

Within the USA, Agilent Technologies can supply parts through a direct mail order system. There are several advantages to this system:

- Direct ordering and shipping from the Agilent Technologies parts center in California, USA.
- No maximum or minimum on any mail order. (There is a minimum amount for parts ordered through a local Agilent Technologies Sales Office when the orders require billing and invoicing.)
- Prepaid transportation. (There is a small handling charge for each order.)
- No invoices.



In order for Agilent Technologies to provide these advantages, please send a check or money order with each order.

Mail order forms and specific ordering information are available through your local Agilent Technologies Sales Office. Addresses and telephone numbers are located in a separate document shipped with the manuals.

## Exchange Assemblies

Some parts used in this instrument have been set up for an exchange program. This program allows the customer to exchange a faulty assembly with one that has been repaired, calibrated, and performance-verified by the factory. The cost is significantly less than that of a new part. The exchange parts have a part number in the form XXXXX-695XX.

After receiving the repaired exchange part from Agilent Technologies, a United States customer has 30 days to return the faulty assembly. For orders not originating in the United States, contact the local Agilent Technologies service organization. If the faulty assembly is not returned within 30 days, the customer will be charged an additional amount. The additional amount will be the difference in price between a new assembly and that of an exchange assembly.

## Exploded Views

The following exploded views provide a graphical representation of the oscilloscope at the time this manual was released. Not all parts are shown. Your parts may be slightly different than those shown. These views provide reference designator numbers that map to those used in the parts list table in this chapter.

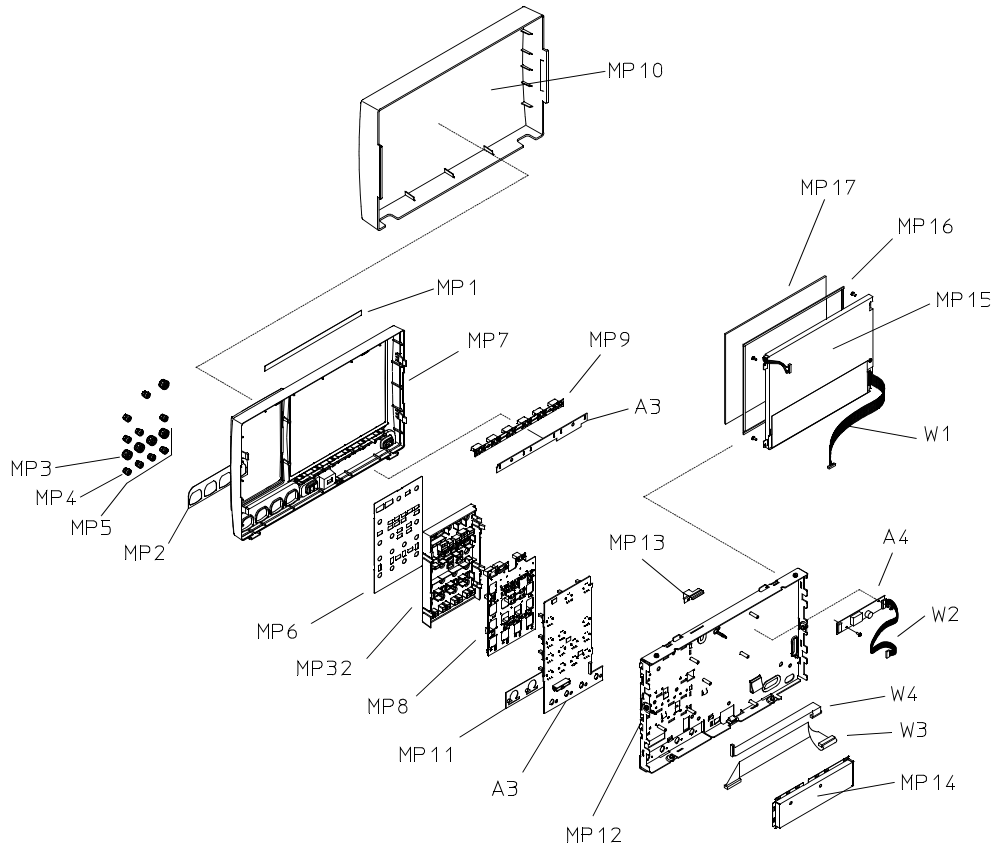

**Figure 1** Exploded View 1 of 2

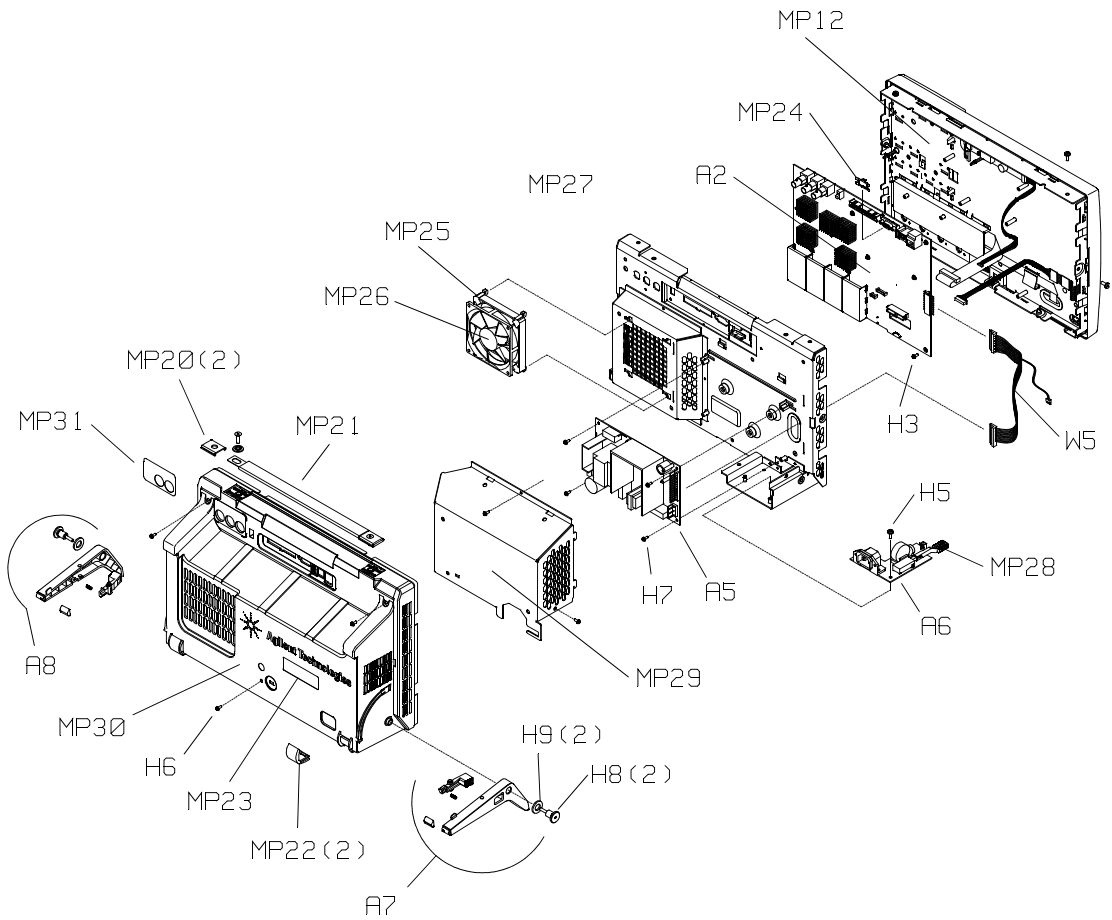

Figure 2 Exploded View 2 of 2

## Replaceable Parts List

The information given for each part consists of the following:

- Reference designation.
- Agilent Technologies part number.
- Total quantity (QTY) in the instrument or on assembly.
- Description of the part.

**Table 1** Replaceable Parts

Ref Des	Agilent Part Number	Qty	Description
A2	54690-66501	1	2-ch 350 MHz system board
A2	54691-66501	1	4-ch 350 MHz system board
A2	54692-66501	1	2-ch 500 MHz system board
A2	54693-66501	1	4-ch 500 MHz system board
A2	54695-66501	1	4-ch 1 GHz system board
A3	54695-66518	1	2-ch keyboard assembly
A3	54695-66519	1	4-ch keyboard assembly
A4	0950-4068	1	Inverter, dual backlight
A5	0950-4691		Power Supply AC/DC SWG 110W Single O/P
A6	54684-66516	1	AC line filter/power switch PC board assembly
A7	54695-68708	1	Tilting Leg Right Assembly
A8	54695-68709	1	Tilting Leg Left Assembly
H1	1400-0611	2	Clamp-FL-CA 1-WD PVC
H2	54684-42202	1	Hole plug front panel (2 Channel only, not shown)













Ref Des	Agilent Part Number	Qty	Description
H3	0515-0372	13	Screw-Machine w/Crest-Cup-Con-Wshr Pan-HD TORX-T10 M3X0.5 8mm-LG SST-300 Passivate
H4	0515-0658	4	Screw-Machine w/Crest-Cup-Con-Wshr Pan-HD TORX-T6 M2X0.4 6mm-LG SST-300 Passivate
H5	0515-2143	14	Screw-Machine w/Patch-LK Pan-HD TORX-T20 M4X0.7 6mm-LG SST-300 Passivate
H6	2950-0054	3	Screw-Machine w/Patch-LK 90-Deg_FLT-HD TORX-T20 M5X0.8 16mm-LG SST-300 Passivate
H7	5022-6627	4	Screw-Machine w/Split-Lock-Flat-Wshr Pan-HD TORX-T10 M3X0.5 8mm-LG SST-300 passivate
H8	54695-26301	2	Screw-Shoulder
H9	3050-2320	2	Washer-Flat Non-metalic 10.5mm ID 20mm-OD 2mm-tHK Polyamide
H10	0515-2049	2	Screw-Machine w/Patch-LK 90-DEG-FLT-HD TORX-T20 M5X0.8 16mm-LG SST-300 Passivate
H11	2190-0068	3	Washer-LK Intl T 1/2 In. .505 IN-ID
MP1	54690-94301	1	ID Label 2 Ch DSO 350 MHz
MP1	54690-94302	1	ID Label 2 Ch MSO 350 MHz
MP1	54691-94301	1	ID Label 4 Ch DSO 350 MHz
MP1	54691-94302	1	ID Label 4Ch MSO 350 MHz
MP1	54692-94301	1	ID Label 2 Ch DSO 500 MHz
MP1	54692-94302	1	ID Label 2 Ch MSO 500 MHz
MP1	54693-94301	1	ID Label 4 Ch DSO 500 MHz
MP1	54693-94302	1	ID Label 4 Ch MSO 500 MHz
MP1	54695-94301	1	ID Label 4 Ch DSO 1GHz
MP1	54695-94302	1	ID Label 4 Ch MSO 1GHz
MP2	54695-94306	1	2-Channel BNC Label
MP2	54695-94307	1	4-Channel BNC Label
MP3	54913-47402	5	Knob 18mm Flint Gray

## 6 Replaceable Parts

Ref Des	Agilent Part Number	Qty	Description
MP4	54913-47401	9	Knob 12mm Flint Gray
MP5	54695-94310	1	2 CH Label Colored Knob Set
MP5	54913-94300	1	Label - Colored Knob Set
MP6	54695-94303	1	2 CH Control Panel Label
MP6	54695-94304	1	4 CH Control Panel Label
MP7	54695-42201	1	Bezel
MP8	54695-41902	1	Keypad - Main 4 Channel
MP9	54695-41903	1	Keypad - Soft
MP10	54913-44101	1	Cover - Front
MP11	54684-94314	1	Auto Probe Label
MP12	54695-00101	1	Front Deck
MP13	54695-00104	1	Inverter Cable Shield
MP14	54695-00601	1	Cable Cover
MP15	2090-0947	1	Display LCD 12.1 Inch TFT (210x270.9x10.9mm)
MP16	54695-47101	1	Display Gasket
MP17	01680-88001	1	Lens
MP20	5041-9607	2	Cap - Strap Handle
MP21	54695-68711	1	Strap Handle
MP22	54695-44701	2	Foot Pad
MP23	5090-4157	1	Serial Label
MP24	54695-00105	1	Video Connector Ground Plate
MP25	54684-44701	1	Fan Mount
MP26	54684-68501	1	Fan
MP27	54695-00102	1	Rear Deck
MP28	54695-43901	1	Extender, Pwr Switch
MP29	54695-00103	1	Power Supply Cover
MP30	54695-44401	1	Bucket

Ref Des	Agilent Part Number	Qty	Description
MP31	54695-94309	1	2 CH Rear Label
MP32	54913-40201	1	Panel Control
W1	54695-61601	1	LVDS Display Cable
W2	54695-61602	1	Inverter Cable
W3	54684-61601	1	Cable - Keyboard
W4	54695-61604	1	Softkeyboard Cable
W5	54695-61603	1	Cable - DC
W6		0-1	Power cord option 900 3-COND 2-M-LG 13A-FUS
W6		0-1	Power cord option 901, Australia
W6		0-1	Power cord option 902, Europe
W6		0-1	Power cord option 903, U.S.A.
W6		0-1	Power cord option 906, Switzerland
W6		0-1	Power cord option 912, Denmark
W6		0-1	Power cord option 917, Africa
W6		0-1	Power cord option 918, Japan
W6		0-1	Power cord option 919, Israel
W6		0-1	Power cord option 920, Argentina
W6		0-1	Power cord option 921, Chile
W6		0-1	Power cord option 922, China
W6		0-1	Power cord option 927, Thailand

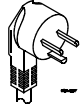
Table 2 Power Cords

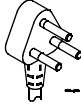
Plug Type	Cable Part Number	Plug Type	Cable Part Number
Opt 900 (U.K.) 	8121-1579	Opt 918 (Japan) 	8121-1603
Opt 901 (Australia) 	8121-1581	Opt 919 (Israel) 	8121-1662
Opt 902 (Europe) 	8121-1580	Opt 920 (Argentina) 	8121-1599
Opt 903 (U.S.A.) 	8121-1609	Opt 921 (Chile) 	8121-1600
Opt 906 (Switzerland) 	8121-1602	Opt 922 (China) 	8121-1606
Opt 912 (Denmark) 	8121-1601	Opt 927 (Thailand) 	8120-0674
Opt 917 (India) 	8121-1604	Opt 923 (South Africa) Opt 930 (Brazil) Opt 931 (Taiwan) Opt 932 (Cambodia)	8121-1641 8121-1613 8121-1637 8121-1633



# Index

## A

AC input board removal, 101  
assemblies  
    exchange, 105  
    replacing, 81

## B

backlight inverter removal, 97  
bandwidth  
    verification, 37

## C

cabinet, removing, 83  
calibration, 59  
cautions, 67, 69, 75, 82, 100  
certificate of calibration, 59  
channels  
    problem solving, 65  
cleaning the instrument, 115  
compensating your probe, 71  
connecting for threshold test, 30

## D

digital channel  
    testing, 27  
    verification, 28  
digital channels, 4  
display  
    assembly removal, 91  
    problem solving, 64

## E

equipment, test, 22  
exchange assemblies, 105

exploded view  
    front panel, 106  
    instrument, 107

## F

Fluke MET/CAL procedures, 24  
front panel  
    exploded view, 106  
    removal, 86

## H

handle, removing, 84  
horizontal  
    accuracy verification, 42

## I

internal self-tests, 79

## K

keyboard, removal, 88

## L

LED, startup sequence, 68  
lid, removal, 85

## M

making test connector, 25  
measurement accuracy, voltage, 32  
measurement category, 15  
    definitions, 15

## N

NIST, 59

## O

ordering parts, 104  
overvoltage category, 17

## P

parts  
    list, 108  
    ordering, 104  
perform user cal, 59  
performance  
    test record, 54  
pollution degree, 17  
    definitions, 17  
power  
    cord list, 111  
    supply removal, 100  
    supply shield, removal, 98  
    test points, 73, 74  
power requirements, 14  
probes  
    compensating, 71  
    problem solving, 63

## R

record tests, 54  
remove  
    AC input board, 101  
    backlight inverter, 97  
    cabinet, 83  
    display assembly, 91  
    front panel, 86  
    handle, 84  
    keyboard, 88  
    power supply, 100  
    power supply shield, 98  
    storage lid, 85

## Index

replaceable parts list, 108  
replacing assemblies, 81  
run self-tests, 79

## S

safety notice, 57, 67, 68  
self-alignment, user cal, 59  
self-tests, 79  
specifications, 18  
startup sequence, 68  
status, User Cal, 62  
status, user cal, 59  
storage lid, removal, 85

## T

test  
  connector, constructing, 25  
  digital channels, 27  
  equipment, 22  
  points, power, 73, 74  
  record, 54  
threshold  
  accuracy, digital channel, 28  
  test diagram, 30  
trace display  
  problem solving, 64  
transient withstand capability, 16  
trigger  
  sensitivity, 44  
  sensitivity, external, 48, 51  
  sensitivity, internal, 46  
troubleshooting, 63  
  display, 77  
  equipment required, 68  
  fan, 78  
  flowchart, 72  
  power supply, 75

## U

user calibration, 59

## V

verify  
  bandwidth, 37  
  digital channel, 28  
  horizontal accuracy, 42  
  trigger, 44  
voltage measurement accuracy, 32

## W

warnings, 82, 98  
warranted specifications, 18

## Safety Notices

This apparatus has been designed and tested in accordance with IEC Publication 1010, Safety Requirements for Measuring Apparatus, and has been supplied in a safe condition. This is a Safety Class I instrument (provided with terminal for protective earthing). Before applying power, verify that the correct safety precautions are taken (see the following warnings). In addition, note the external markings on the instrument that are described under "Safety Symbols."

### Warnings

Before turning on the instrument, you must connect the protective earth terminal of the instrument to the protective conductor of the (mains) power cord. The mains plug shall only be inserted in a socket outlet provided with a protective earth contact. You must not negate the protective action by using an extension cord (power cable) without a protective conductor (grounding). Grounding one conductor of a two-conductor outlet is not sufficient protection.

Only fuses with the required rated current, voltage, and specified type (normal blow, time delay, etc.) should be used. Do not use repaired fuses or short-circuited fuseholders. To do so could cause a shock or fire hazard.

If you energize this instrument by an auto transformer (for voltage reduction or mains isolation), the common terminal must be connected to the earth terminal of the power source.

Whenever it is likely that the ground protection is impaired, you must make the instrument inoperative and secure it against any unintended operation.

Service instructions are for trained service personnel. To avoid dangerous electric shock, do not perform any service unless qualified to do so. Do not attempt internal service or adjustment unless another person, capable of rendering first aid and resuscitation, is present.

Do not install substitute parts or perform any unauthorized modification to the instrument.

Capacitors inside the instrument may retain a charge even if the instrument is disconnected from its source of supply.

Do not operate the instrument in the presence of flammable gasses or fumes. Operation of any electrical instrument in such an environment constitutes a definite safety hazard.

Do not use the instrument in a manner not specified by the manufacturer.

### To clean the instrument

If the instrument requires cleaning: (1) Remove power from the instrument. (2) Clean the external surfaces of the instrument with a soft cloth dampened with a mixture of mild detergent and water. (3) Make sure that the instrument is completely dry before reconnecting it to a power source.

## Safety Symbols



Instruction manual symbol: the product is marked with this symbol when it is necessary for you to refer to the instruction manual in order to protect against damage to the product.



Hazardous voltage symbol.



Earth terminal symbol: Used to indicate a circuit common connected to grounded chassis.